

 CLOSE THE DOORS	 TÜREN SCHLIESSEN
 FERMER LES PORTES	 DEUREN SLUITEN
 CHIUDERE LE PORTE	 CERRAR LAS PUERTAS
 DÖRRNA SÅ VÄLA STÄNGA	 HOLD ALTD LADERE LUKKED
 随手关门	 開けたらすぐ閉めること

Type 90









MADE IN ITALY

 TESSŐR BECSÜRN AZ AJTÓKAT	 TÜREN SCHLIESSEN
 PŘIŠŤ ZAVŘÍTĚ DVĚŘI	 DEUREN SLUITEN
 PŘIŠŤ ZAVŘEJTE DVĚŘI	 KÄBINETE ZUKNIPPEN
 ZAMKNIĆ DRZWI	 TÜREN SCHLIESSEN

Introduction

Dear Customer,

We are pleased to present our new catalogue of safety cabinets for the storage of chemicals in industries, laboratories or communities.

We hope that this tool will facilitate your search and the suitable choice of our products.

EXACTA products comply with the highest European standards and they guarantee you quality and safety without compromise:

- **EN14470-1** for storage cabinets of inflammable liquids
- **EN14470-2** for storage cabinets of gas cylinders
- **NFX 15-211** for chemical hoods and recirculation filtering cabinets
- **EN14727** for all our cabinet program

Our factory, located near Venice in Italy, has obtained **ISO 9001 :2008** certification by Bureau Veritas. A continuous quality control of our production is ensured by a recognized and independent institute.

The marketing of EXACTA products is ensured by a network of skilled and local partner distributors, which is always at your disposal. Our permanent technical and commercial support assesses your needs and recommends optimal solutions.

For your safety, do not risk and choose quality!

EXACTA is:

- The certainty of having an experienced manufacturer with you
- The assurance of a dedicated and professional team who will give you the best advice

Yours sincerely,

ASEM®

ASEM® reserves the right to make technical changes to the instruments without notice, according to the evolution of technologies and standards. Non-contractual picture.

INTRODUCTION

3

STORAGE CABINETS FOR INFLAMMABLE AND RADIOACTIVE PRODUCTS

• Standard EN14470-1 / Fire tests	6
• Cabinets TYPE90 for inflammables: Safety first!	7
• Storage cabinets for inflammables Series EFOMY11 Grey	8-9
• Storage cabinets for inflammables Series EFOMY11 Yellow	10-11
• Storage cabinets for inflammables Series BBACMY11 Grey	12-13
• Storage cabinets for inflammables Series BBACMY11 Yellow	14-15
• Storage cabinets for inflammable and radioactive products Series EFO RADIO	16-17
• Safety Fire Case	18-19
• Liquid collection system: Waste storage tank	20-21
• Fireproof cabinet accessories	22-23

STORAGE CABINETS FOR GAS CYLINDERS

• Standard EN14470-2	24-25
• Cabinets for the internal storage of gas cylinders - Series EBO	26-27
• Cabinets for the internal and external storage of gas cylinders - Series EBO Basic	28-29
• Certificated box for the external storage of gas cylinders - Series LED	30
• Box for the external storage of gas cylinders	31

CERTIFIED MULTI-RISK CABINETS SERIES COMBISTORAGE

• Combined underbench storage cabinets series COMBISTORAGE	32-37
• Combined storage cabinets with 2 compartments Series COMBISTORAGE 2	38-39
• Combined storage cabinets with 3/4 compartments Series COMBISTORAGE 3/4	40-41
• Combined storage cabinets Series COMB ISTOREGE 120 FIRE90	42-43
• Combined storage cabinets Series COMBISTORAGE 60 FIRE90	44-45

STORAGE CABINETS FOR CHEMICALS AND CORROSIVE SUBSTANCES

• EN61010 certified storage cabinets for chemicals Series ECO plain doors	46-47
• EN61010 certified storage cabinets for chemicals Series ECO glazed doors	48-49
• Storage cabinets for chemicals Series ECO plain doors	50-51
• Storage cabinets for chemicals Series ECO glazed doors	52-53
• Storage cabinets for corrosive substances Series WOODLINE	54-55
• Storage cabinets for corrosive substances Series High density PVC	56-57
• Box for poison storage	58
• Safety cabinets for hazardous products Series E-LINE	59
• Safety cabinets for storing cytotoxic products	60-61

ASEM® reserves the right to make technical changes to the instruments without notice, according to the evolution of technologies and standards. Non-contractual pictures.

FILTERING VENTILATED CABINETS AND HOODS

• Standard NFX15-211	62-63
• Series ECO F - Fixed shelves - Glass doors	64
• Ventilated cabinets and hoods with molecular filtration certified NF15-211 Technical features of the fresh air box with filtration	65
• Series ECO F - Sliding shelves - Glass doors - Technical feature of cabinets	66
• Ventilated cabinets and hoods with molecular filtration certified NF15-211 Technical features of the fresh air box with filtration	67
• Hoods CHEMIHOOD PLUS with molecular filtration Technical features of the fresh air box with filtration	68-69

HOODS

• Hoods CHEMIHOOD with connection	70-71
-----------------------------------	-------

SERIES PHYTO

• Storage of phytosanitary products	72-73
• Storage cabinets for pest control products and other agricultural products	74-75

VENTILATION

• Ventilation choice guide. The importance of filter replacement.	76-77
• Ventilation units with external connection	78
• Storage cabinet fans for inflammables	79
• Fresh air box with filtration Certified according to standard NFX15-211	80-81

SAFETY SHELVING

• Safety shelving made of modular epoxy steel	82
• Safety shelving non modular aluminium	83

PRACTICAL INFORMATION

• Safety shelving made of modular epoxy steel	84-85
• Delivery and installation sheet	86

STORAGE CABINETS
FOR INFLAMMABLE AND
RADIOACTIVE PRODUCTS

STORAGE CABINETS
FOR GAS CYLINDERS

CERTIFIED MULTI-RISK
COMBUSTION
CABINETS SERIES

STORAGE CABINETS
FOR CHEMICALS AND
CORROSIVE SUBSTANCES

FILTERING
VENTILATED CABINETS
AND HOODS

HOODS

SERIES PHYTO

VENTILATION

EQUIPMENTS

Standard EN14470-1



The European standard EN 14470-1 refers to cabinets freely positioned and to wall-mounted cabinets for the storage of inflammables.

All EXACTA cabinet models have undergone a destructive test in a fire room performed in an independent accredited laboratory.

➔ STANDARD DESCRIPTION

➔ FIRE TEST

The wall of the cabinet must be positioned in the fire room at a distance of 100 mm from the wall. The fire resistance of the cabinet must be validated by the destructive test of an identical model. Possible reductions in the dimensions of the cabinet tested:

- Height and width max. 100 mm
- Depth max. 150 mm

The temperature increase inside the cabinet should not exceed 180 K or 200 °C. According to the time taken to reach this temperature, the cabinet will be classified as Type 15, 30, 60 or 90 min.

These different flammability classes allow leaving sufficient time for the staff to leave the laboratory and for the firefighters to get in before the stored flammable products may cause fire.

Each EXACTA cabinet model has passed the compliance control according to standard EN14470-1 and it has the certificates of tests carried out by Bureau Veritas (BV).

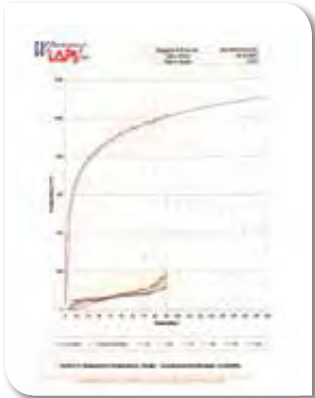

Report of fire resistance test with Temperature/Time diagram. Contact thermocouple increase.

➔ CONSTRUCTION

The cabinet doors must close automatically in case of fire.

The side and rear walls must have the same construction and the same thickness.

On the other hand, the requirements of the standard cover the cabinet construction itself and its capacity to withstand external fire conditions (fire tests carried out according to ISO 834-1 [1] and EN 1363-1).

The tray volume must contain: at least 110 % of the volume of the largest container stored in the cabinet or 10 % of the total volume stored.



Exacta cabinet series EFO BEFORE fire resistance test.

➔ SIGNALLING

The cabinets must be equipped with suitable signals: standard pictograms complying with ISO 3864 (inflammables), maximum load per shelf, fire resistance of the model (15, 30, 60 or 90 minutes).

➔ QUALITY CONTROL

EXACTA submitted its safety cabinet manufacturing to a continuous and extremely rigorous check by Bureau Veritas.

So twice a year, BV checks the production and verifies the quality and the manufacturing process.



Exacta cabinet series EFO AFTER fire resistance test.

EXACTA will make all the cabinet documents and certifications available.

Storage cabinets for inflammables



**FIRE-RESISTANT
CERTIFIED**
90 minutes (TYPE 90)



➤ MAXIMUM PROTECTION FOR SAFETY FIRST!

For obvious safety reasons (fire, corrosion, intoxication...), all the high or low flammables must be handled and stored in fireproof cabinets (fire resistance of 90 minutes) certified according to standard EN14470-1.

We opted for the maximum safety by offering a complete range of fire-resistant cabinets TYPE 90 minutes.

The cabinet construction, the automatic closing of the doors (present on all our models), the thermo-expanding seals and the fire dampers ensure the cabinet containment for 90 minutes and a maximum protection of the people.

➤ WHAT DOES IT MEAN FOR THE USER

- A use according to the regulations
- A maximum use safety
- A certification documentation identifying the safety cabinet (traceability)

Series EFOMY11 Grey

Certified according to EN14470-1
standard Type 90 & EN14727

**FIRE-RESISTANT
CERTIFIED**
90 minutes (TYPE 90)



EOF232BMY11



EOF239BMY11



Door closer PS50MY11



Fire-extinguisher
K89033



Alarm system
AT100

Easy replacement of spare parts
in case of damage

→ TECHNICAL FEATURES:

- Completely made of an electrogalvanized steel plate with a thickness of 1 - 1.5 mm, cold bent - Grey RAL7035
- External finishing made of acidproof epoxy resin and passage through a thermal tunnel a 200 °C
- Cabinet isolation through some high density rock wool panels and some calcium sulphate panels
- Internal finishing with melamine panels highly resistant to chemical and aggressive vapours
- Structure allowing replacing spare parts if necessary
- Automatic door closing when the ambient temperature exceeds 50 °C
- 30 mm thermo-expanding isolation seals which in case of temperature rise ensure a perfect cabinet sealing according to standard EN14470-1
- Air inlet and outlet with certified fire dampers closing ducts when the temperature exceeds 70 °C according to standard 4102-6
- Prearrangement for ventilation through a Ø 100 mm flange for an external connection or a filtering ventilation system (see the chapter on ventilation)
- **Closing and locking system of the doors allowing keeping the doors open** and closing them automatically in case of ambient temperature higher than 50 °C
- Spark resistant hinge ensuring a perfect door solidity
- Cabinet equipped with earthing
- Leveling jacks
- Door key lock
- 3 shelves made of **painted (BASIC series)** or of **stainless steel (EASY series)** whose height can be adjusted, 1 tray with grid
- Shelf fastening on aluminium eyelets excluding all risks of spark
- Fire tested shelves
- ISO 3864: Pictogram signalling
- Certified as fire-resistant for **90 minutes**, according to standard **EN14470-1 BV (Bureau Veritas)**
- Certifiée conforme à la norme **EN14727 BV (Bureau Veritas)**

→ SERIE EFOMY11

CODE	DESCRIPTION	OUTER DIMENSIONS (WxDxH) mm	INNER DIMENSIONS (WxDxH) mm	INTERNAL EQUIPMENT	STORAGE CAPACITY*	Weight (kg)
EOF239BMY11**	Cabinet series EFOMY11 BASIC with 1 door	595x600x1950	496x446x1540	3 shelves made of painted steel (max. load 60 KG evenly distributed) + 1 retention tray with grid (capacity 20 Litres)	80 / 100	235
EOF239MY11**	Cabinet series EFOMY11 EASY with 1 door	595x600x1950	496x446x1540	3 shelves made of stainless steel (max. load 60 KG evenly distributed) + 1 retention tray with grid (capacity 20 Litres)	80 / 100	235
EOF240BMY11** NEW	Cabinet series EFOMY11 BASIC with 1 door - W900	895x600x1950	796x446x1540	3 shelves made of painted steel (max. load 70 KG evenly distributed) + 1 retention tray with grid (capacity 25 Litres)	128 / 160	NC
EOF240MY11** NEW	Cabinet series EFOMY11 EASY with 1 door - W900	895x600x1950	796x446x1540	3 shelves made of stainless steel (max. load 70 KG evenly distributed) + 1 retention tray with grid (capacity 25 Litres)	128 / 160	NC
EOF232BMY11	Cabinet series EFOMY11 BASIC with 2 doors	1200x600x1950	1095x446x1540	3 shelves made of painted steel (max. load 80 KG evenly distributed) + 1 retention tray with grid (capacity 45 Litres)	176 / 220	390
EOF232MY11	Cabinet series EFOMY11 EASY with 2 doors	1200x600x1950	1095x446x1540	3 shelves made of stainless steel (max. load 80 KG evenly distributed) + 1 retention tray with grid (capacity 45 Litres)	176 / 220	390

*Approximate capacity in bottles holding 1 litre per cabinet

**Left door opening. Add «D» to the item code for the right door opening

→ INTERNAL EQUIPMENT (optional)

CODE	DESCRIPTION	DIMENSIONS (WxDxH) mm	RETENTION VOLUME (LITRES)	STORAGE CAPACITY*
RIP60VMY11	Additional shelf made of painted steel for cabinet with 1 door W600	493x420x39	7	20 / 25
RIP90VMY11	Additional shelf made of painted steel for cabinet with 1 door W900	793X420X39	12	32 / 40
RIP120VMY11	Additional shelf made of painted steel for cabinet with 2 doors	1094x420x39	16	44 / 55
RIP60XMY11	Additional shelf made of stainless steel for cabinet with 1 door W600	493x420x39	7	15/20
RIP90XMY11	Additional shelf made of stainless steel for cabinet with 1 door W900	793X420X39	12	32 / 40
RIP120XMY11	Additional shelf made of stainless steel for cabinet with 2 doors	1094x420x39	16	30/40
PS50SMY11	Replacement system with closing thermal fuse - left door	-	-	-
PSS0MY11	Replacement system with closing thermal fuse - right door	-	-	-
ZOCPAL60	Pallet truck base plate W60	595x600x110	-	-
ZOCPAL90	Pallet truck base plate W90	895x600x110	-	-
ZOCPAL120	Pallet truck base plate W120	1200x600x110	-	-
CHEMIROLL	Wheel board to move the cabinets (the code ZOCPAL is necessary)	-	-	-
CSFR127	Internal cooling system of the storage cabinet for products with a low flammability degree for high cabinet with 1 door W600	-	-	-
CSFR128	Internal cooling system of the storage cabinet for products with a low flammability degree for high cabinet 2 doors	-	-	-
CSFR129	Internal cooling system of the storage cabinet for products with a low flammability degree for high cabinet with 1 door W900	-	-	-
AT100	Visual and audible alarm system with telephone transmission equipped with a digital thermostat with a T probe (°C) inside the cabinet	-	-	-
TIM24	Daily counter	-	-	-
K89033	Internal carbon dioxide fire-extinguisher with automatic thermal tripping (62 °C)	Ø 90x280	-	-

*Approximate capacity in bottles holding 1 litre

→ VENTILATION (optional)*

CODE	DESCRIPTION	DIMENSIONS (WxDxH) mm
DIAM125BP	Fresh air box with power cable and filter box - outlet diam. 100 mm	290x290x270
EOF100ABPMY11	Fresh air box ATEX with power cable and filter box - outlet diam. 100 mm	257x265x400
K89007	Activated charcoal filter for organic solvents - series EFO (to replace at least 3 times a year)	235x110x15
GFKIT100	External connection kit (1 metre of hose diam. 100 mm and 2 clamps)	Ø 100 - W 1000 mm
CFN	Fresh air box with molecular filtration according to standard NFX15-211, with visual and audible alarm	550x500x220
CFNLH	Molecular filtration box according to standard NFX15-211	550x500x220
ADCFNMY11	Adapter for CFN box	595x500x80
EOAS	Activated charcoal filter for solvents (prefilter included)	510x405x60
EOBE	Activated charcoal filter for acids (prefilter included)	510x405x60
EOMP	Activated charcoal filter for solvents and acids (prefilter included)	510x405x60
EOPF	Prefilter	510x405x15

* To obtain the complete list of the connection accessories, see the chapter on ventilation of this catalogue and the current price list

Series EFOMY11 Yellow

Certified according to EN14470-1
standard Type 90 & EN14727

**FIRE-RESISTANT
CERTIFIED**
90 minutes (TYPE 90)



EOF232BMY11



EOF239BMY11



Painted steel shelf
RIP60VMY11



Stainless steel shelf
RIP60XMY11

High storage capacity

→ TECHNICAL FEATURES:

- Completely made of an electrogalvanized steel plate with a thickness of 1 - 1.5 mm, cold bent - Yellow RAL1021
- External finishing in acidproof epoxy resin and passage through a thermal tunnel at 200 °C
- Cabinet isolation through some high density rock wool panels and some calcium sulphate panels
- Internal finishing with melamine panels highly resistant to chemical and aggressive vapours
- Structure allowing replacing spare parts if necessary
- Automatic door closing when the ambient temperature exceeds 50 °C
- 30 mm thermo-expanding isolation seals which in case of temperature rise ensure a perfect cabinet sealing according to standard EN14470-1
- Air inlet and outlet with certified fire dampers closing ducts when the temperature exceeds 70 °C according to standard DIN 4102-6
- Prearrangement for ventilation through a Ø 100mm flange for an external connection or a filtering ventilation system (see the chapter on ventilation)
- Closing and locking system of the doors allowing keeping the doors open and closing them automatically in case of ambient temperature higher than 50 °C
- Spark resistant hinge ensuring a perfect door solidity
- Cabinet equipped with earthing
- Leveling jacks
- Door key lock
- 3 shelves made of painted steel (**BASIC** series) or of stainless steel (**EASY** series) whose height can be adjusted, 1 retention tray with grid
- Shelf fastening on aluminium eyelets excluding all risks of spark
- Fire tested shelves
- ISO 3864 : Pictogram signalling
- Certified as fire-resistant for **90 minutes**, according to standard **EN14470-1 BV (Bureau Veritas)**
- Certified according to standard **EN14727 BV (Bureau Veritas)**

→ SERIES EFOMY11

CODE	DESCRIPTION	EXTERNAL DIMENSIONS (WxDxH) mm	INTERNAL DIMENSIONS (WxDxH) mm	INTERNAL EQUIPMENT	STORAGE CAPACITY*	Weight (kg)
EOF239BMY11J **	Yellow cabinet series EFOMY11 BASIC with 1 door	595x600x1950	496x446x1540	3 shelves made of painted steel (max. load 60 KG evenly distributed) + 1 retention tray with grid (capacity 20 Litres)	60 / 80	235
EOF239MY11J **	Yellow cabinet series EFOMY11 EASY with 1 door	595x600x1950	496x446x1540	3 shelves made of stainless steel (max load 60 KG evenly distributed) + 1 retention tray with grid (capacity 20 Litres)	60 / 80	235
EOF240BMY11J ** NEW	Yellow cabinet series EFOMY11 BASIC with 1 door - W900	895x600x1950	796x446x1540	3 shelves made of painted steel (max. load 70 KG evenly distributed) + 1 retention tray with grid (capacity 25 Litres)	128 / 160	NC
EOF240MY11J ** NEW	Yellow cabinet series EFOMY11 EASY with 1 door - W900	895x600x1950	796x446x1540	3 shelves made of stainless steel (max load 70 KG evenly distributed) + 1 retention tray with grid (capacity 25 Litres)	128 / 160	NC
EOF232BMY11J	Yellow cabinet series EFOMY11 BASIC with 2 doors	1200x600x1950	1095x446x1540	3 shelves made of painted steel (max. load 80 KG evenly distributed) + 1 retention tray with grid (capacity 45 Litres)	120 / 160	390
EOF232MY11J	Yellow cabinet series EFOMY11 EASY with 2 doors	1200x600x1950	1095x446x1540	3 shelves made of stainless steel (max load 80 KG evenly distributed) + 1 retention tray with grid (capacity 45 Litres)	120 / 160	390

*Approximate capacity in bottles holding 1 litre per cabinet

**Left door opening. Add «D» to the item code for the right door opening

→ INTERNAL EQUIPMENT (optional)

CODE	DESCRIPTION	DIMENSIONS (WxDxH) mm	RETENTION VOLUME (LITRES)	STORAGE CAPACITY*
RIP60VMY11	Additional shelf made of painted steel for cabinet with 1 door W600	493x420x39	7	20 / 25
RIP90VMY11	Additional shelf made of painted steel for cabinet with 1 door W900	793x420x39	12	32 / 40
RIP120VMY11	Additional shelf made of painted steel for cabinet with 2 doors	1094x420x39	16	44 / 55
RIP60XMY11	Additional shelf made of stainless steel for cabinet with 1 door W600	493x420x39	7	15/20
RIP90XMY11	Additional shelf made of stainless steel for cabinet with 1 door W900	793x420x39	12	32 / 40
RIP120XMY11	Additional shelf made of stainless steel for cabinet with 2 doors	1094x420x39	16	30/40
PS50SMY11	Replacement system with closing thermal fuse -left door	-	-	-
PS50MY11	Replacement system with closing thermal fuse -right door	-	-	-
ZOCPAL60	Pallet truck base plate L60	595x600x110	-	-
ZOCPAL90	Pallet truck base plate L90	895x600x110	-	-
ZOCPAL120	Pallet truck base plate L120	1200x600x110	-	-
CHEMIROLL	Wheel board to move the cabinets (the code ZOCPAL is necessary)	-	-	-
CSFR127	Internal cooling system of the storage cabinet for products with a low flammability degree for high cabinet with 1 door W600	-	-	-
CSFR128	Internal cooling system of the storage cabinet for products with a low flammability degree for high cabinet with 2 doors	-	-	-
CSFR129	Internal cooling system of the storage cabinet for products with a low flammability degree for high cabinet with 1 door W900	-	-	-

*Approximate capacity in bottles holding 1 litre

→ VENTILATION (optional)*

CODE	DESCRIPTION	DIMENSIONS (WxDxH) mm
DIAM125BP	Fresh air box with power cable and filter box - outlet diam. 100 mm	290x290x270
EOF100ABPMY11	Fresh air box ATEX with power cable and filter box - outlet diam. 100 mm	257x265x400
K89007	Activated charcoal filter for organic solvents - series EFO (to replace at least 3 times a year)	235x110x15
GFKIT100	External connection kit (1 metre of hose diam. 100 mm and 2 clamps)	∅ 100 - W 1000 mm
CFN	Air fresh box with molecular filtration according to NFX15-211 standard, with visual and audible alarm	550x500x220
CFNLH	Molecular filtration box manufactured according to standard NFX15-211	550x500x220
ADCFNMY11	Adapter for CFN box	595x500x80
EOAS	Filtre à charbon actif pour solvants (pré-filtre inclus)	510x405x60
EOBE	Filtre à charbon actif pour acides (pré-filtre inclus)	510x405x60
EOMP	Filtre à charbon actif pour solvants et acides (pré-filtre inclus)	510x405x60
EOPF	Pré-filtre	510x405x15

*Pour obtenir la liste complète des accessoires de raccordement, se reporter au chapitre sur la ventilation du présent catalogue et au Tarif en cours

Series BBACMY11 Grey

Certified according to EN14470-1 standard Type 90 & EN14727

**FIRE-RESISTANT
CERTIFIED**
90 minutes (TYPE 90)



EOF232BBACMY11



EOF239BBACMY11



Closing system



Shelf made of painted steel



Alarm system AT100

Closing system allowing keeping the doors open

→ TECHNICAL FEATURES:

- Completely made of an electrogalvanized steel plate with a thickness of 1 - 1,5 mm, cold bent - Grey RAL7035
- External finishing in acidproof epoxy resin and passage through a thermal tunnel at 200 °C
- Cabinet isolation through some high density rock wool panels and some calcium sulphate panels
- Internal finishing with melamine panels highly resistant to chemical and aggressive vapours
- Structure allowing replacing spare parts if necessary
- Automatic door closing when the ambient temperature exceeds 50 °C
- 30 mm thermo-expanding isolation seals which in case of temperature rise ensure a perfect cabinet sealing according to standard EN14470-1
- Air inlet and outlet with certified fire dampers closing ducts when the temperature exceeds 70 °C according to standard DIN 4102-6.
- Prearrangement for ventilation through a Ø 100 mm flange for an external connection or a filtering ventilation system (see the chapter on ventilation)
- Closing and locking system of the doors allowing keeping the doors opened and closing them automatically in case of ambient temperature higher than 50 °C
- Spark resistant hinge ensuring a perfect door solidity
- Cabinet equipped with earthing
- Leveling jacks
- Door key lock
- 3 shelves made of painted or stainless steel (optional) whose height can be adjusted, 1 retention tray with grid
- Shelf fastening on some aluminium eyelets excluding all risks of spark
- Fire tested shelves
- ISO 3864 : Pictogram signalling
- Certified as fire-resistant for **90 minutes**, according to standard **EN14470-1 BV (Bureau Veritas)**
- Certified according to standard **EN14727 BV (Bureau Veritas)**

→ SERIE BBACMY11

CODE	DESCRIPTION	EXTERNAL DIMENSIONS (WxDxH) mm	INTERNAL DIMENSIONS (WxDxH) mm	INTERNAL EQUIPMENT	STORAGE CAPACITY*	Weight (kg)
EOF239BBACMY11**	Cabinet series BBACMY11 with 1 door	595x600x1950	496x446x1540	3 shelves made of painted steel (max. load 60 KG evenly distributed) + 1 retention tray with grid (capacity 20 Litres)	80/100	235
EOF232BBACMY11	Cabinet series BBACMY11 BASIC with 2 doors	1200x600x1950	1095x446x1540	3 shelves made of painted steel (max. load 80 KG evenly distributed) + 1 retention tray with grating (capacity 45 Litres)	176/220	390

*Approximate capacity in bottles holding 1 litre per cabinet

**Left door opening. Add «D» to the item code for the right door opening

→ INTERNAL EQUIPMENT (optional)

CODE	DESCRIPTION	DIMENSIONS (WxDxH) mm	RETENTION VOLUME (LITRES)	STORAGE CAPACITY*
RIP60VMY11	Additional shelf made of painted steel for cabinet with 1 door W600	493x420x39	7	20 / 25
RIP120VMY11	Additional shelf made of painted steel for cabinet with 2 doors	1094x420x39	16	44 / 55
RIP60XMY11	Additional shelf made of stainless steel for cabinet with 1 door W600	493x420x39	7	15/20
RIP120XMY11	Additional shelf made of stainless steel for cabinet with 2 doors	1094x420x39	16	30/40
P550SMY11	Replacement system with closing thermal fuse - left door	-	-	-
P550MY11	Replacement system with closing thermal fuse - right door	-	-	-
ZOCPAL60	Pallet truck base plate W60	595x600x110	-	-
ZOCPAL120	Pallet truck base plate W120	1200x600x110	-	-
CHEMIROLL	Wheel board to move the cabinets (the code ZOCPAL is necessary)	-	-	-
CSFR127	Internal cooling system of the storage cabinet for products with a low flammability degree for high cabinet with 1 door W600	-	-	-
CSFR128	Internal cooling system of the storage cabinet for products with a low flammability degree for high cabinet with 2 doors	-	-	-

*Approximate capacity in bottles holding 1 litre

→ VENTILATION (optional)*

CODE	DESCRIPTION	DIMENSIONS (WxDxH) mm
DIAM125BP	Fresh air box with power cable and filter box - outlet diam. 100 mm	290x290x270
EOF100ABPMY11	Fresh air box ATEX with power cable and filter box - outlet diam. 100 mm	257x265x400
K89007	Activated charcoal filter for organic solvents - series EFO (to replace at least 3 times a year)	235x110x15
GFKIT100	External connection kit (1 metre of hose diam. 100mm and 2 clamps)	∅ 100 - W 1000 mm
CFN	Fresh air box with molecular filtration according to NFX15-211 standard, with visual and audible alarm	550x500x220
CFNLH	Molecular filtration box manufactured according to standard NFX15-211	550x500x220
ADCFNMY11	Adapter for CFN box	595x500x80
EOAS	Activated charcoal filter for solvents (prefilter included)	510x405x60
EOBE	Activated charcoal filter for acids (prefilter included)	510x405x60
EOMP	Activated charcoal filter for solvents and acids (prefilter included)	510x405x60
EOPF	Prefilter	510x405x15

* To obtain the complete list of the connection accessories, see the chapter on ventilation of this catalogue and the current price list

Series BBACMY11 Yellow

Certified according to EN14470-1 standard Type 90 & EN14727



**FIRE-RESISTANT
CERTIFIED**
90 minutes (TYPE 90)



EOF239BBACMY11J



EOF232BBACMY11J



EOF232BBACMY11J



Closing system allowing keeping the door open in any position



Shelf made of painted steel RIP60VMY11

Ideal for industry!

→ TECHNICAL FEATURES:

- Completely made of an electrogalvanized steel plate with a thickness of 1 - 1.5 mm, cold bent - Yellow RAL1021
- External finishing in acidproof epoxy resin and passage through a thermal tunnel at 200 °C
- Cabinet isolation through some high density rock wool panels and some calcium sulphate panels
- Internal finishing with melamine panels highly resistant to chemical and aggressive vapours
- Structure allowing replacing the parts if necessary
- Automatic door closing when the ambient temperature exceeds 50 °C
- 30 mm thermo-expanding isolation seals which in case of temperature rise ensure a perfect cabinet sealing according to standard EN14470-1
- Air inlet and outlet with certified fire dampers closing ducts when the temperature exceeds 70 °C according to standard e DIN 4102-6.
- Prearrangement for ventilation through a Ø 100 mm flange for an external connection or a filtering ventilation system (see the chapter on ventilation)
- **Closing and locking system of the doors ouvertes** allowing keeping the doors open and closing them automatically in case of ambient temperature higher than 50 °C
- Spark resistant hinge ensuring a perfect door solidity
- Cabinet equipped with earthing
- Leveling jacks
- Door key lock
- 3 shelves made of painted or stainless steel (optional) whose height can be adjusted, 1 retention tray with grid
- Shelf fastening on aluminium eyelets excluding all risks of spark
- Fire tested shelves
- ISO 3864: Pictogram signalling
- Certified as fire-resistant for **90 minutes**, according to standard **EN14470-1 BV (Bureau Veritas)**
- Certified according to standard **EN14727 BV (Bureau Veritas)**

→ SERIES BBACMY11

CODE	DESCRIPTION	EXTERNAL DIMENSIONS (WxDxH) mm	INTERNAL DIMENSIONS (WxDxH) mm	INTERNAL EQUIPMENT	STORAGE CAPACITY*	Weight (kg)
EOF239BBACMY11J**	Cabinet series BBACMY11 with 1 door	595x600x1950	496x446x1540	3 shelves made of painted steel (max. load 60 KG evenly distributed) + 1 retention tray with grid (capacity 20 Litres)	80/100	235
EOF232BBACMY11J	Cabinet series BBACMY11 BASIC with 2 doors	1200x600x1950	1095x446x1540	3 shelves made of painted steel (max. load 80 KG evenly distributed) + 1 retention tray with grid (capacity 45 Litres)	176/220	390

*Approximate capacity in bottles holding 1 litre per cabinet

**Left door opening. Add «D» to the item code for the right door opening

→ INTERNAL EQUIPMENT (optional)

CODE	DESCRIPTION	DIMENSIONS (WxDxH) mm	RETENTION VOLUME (LITRES)	STORAGE CAPACITY*
RIP60VMY11	Additional shelf made of painted steel for cabinet with 1 door W600	493x420x39	7	20 / 25
RIP120VMY11	Additional shelf made of painted steel for cabinet with 2 doors	1094x420x39	16	44 / 55
RIP60XMY11	Additional shelf made of stainless steel for cabinet with 1 door W600	493x420x39	7	15/20
RIP120XMY11	Additional shelf made of stainless steel for cabinet with 2 doors	1094x420x39	16	30/40
PS50SMY11	Replacement system with closing thermal fuse - left door	-	-	-
PS50MY11	Replacement system with closing thermal fuse - right door	-	-	-
ZOCPAL60	Pallet truck base plate W60	595x600x110	-	-
ZOCPAL120	Pallet truck base plate W120	1200x600x110	-	-
CHEMIROLL	Wheel board to move the cabinets (the code ZOCPAL is necessary)	-	-	-
CSFR127	Internal cooling system of the storage cabinet for products with a low flammability degree for high cabinet with 1 door W600	-	-	-
CSFR128	Internal cooling system of the storage cabinet for products with a low flammability degree for high cabinet with 2 doors	-	-	-

*Approximate capacity in bottles holding 1 litre

→ VENTILATION (optional)*

CODE	DESCRIPTION	DIMENSIONS (WxDxH) mm
DIAM125BP	Fresh air box with power cable and filter box - outlet diam. 100 mm	290x290x270
EOF100ABPMY11	Fresh air box ATEX with power cable and filter box - outlet diam. 100 mm	257x265x400
K89007	Activated charcoal filter for organic solvents - series EFO (to replace at least 3 times a year)	235x110x15
GFKIT100	External connection kit (1 metre of hose diam. 100 mm and 2 clamps)	Ø 100 - W 1000 mm
CFN	Fresh air box with molecular filtration according to standard NFX15-211, with visual and audible alarm	550x500x220
CFNLH	Molecular filtration box built according to standard NFX15-211	550x500x220
ADCFNMY11	Adapter for CFN box	595x500x80
EOAS	Activated charcoal filter for solvents (prefilter included)	510x405x60
EOBE	Activated charcoal filter for acids (prefilter included)	510x405x60
EOMP	Activated charcoal filter for solvents and acids (prefilter included)	510x405x60
EOPF	Prefilter	510x405x15

* To obtain the complete list of the connection accessories, see the chapter on ventilation of this catalogue and the current price list



Series EFOMY11 RADIO

Certified according to EN14470-1 Type 90



K89074



K89074 - Open

**FIRE-RESISTANT
CERTIFIED**
90 minutes (TYPE 90)



K89076



K89075



K89076
+ K89132



Several thicknesses of lead can be obtained according to the radioactivity of the stored products.

Our design department is at your disposal to carry out your projects.

Completely made of stainless steel with a layer of lead whose thickness can vary from 2 to 5 mm



→ TECHNICAL FEATURES:

- Completely made of electrogalvanized stainless steel AISI304 with a thickness from 1 to 1.5 mm, cold bent
- Cabinet isolation through some high density rock wool panels and some calcium sulphate panels
- Internal finishing with melamine and lead panels whose **thickness varies from 2 and 5 mm** according to the level of radioactivity of the stored products (please contact us)
- Structure allowing replacing spare parts if necessary
- Automatic door closing when the ambient temperature exceeds 50 °C
- 30 mm thermo-expanding isolation seals that in case of temperature rise ensure a perfect cabinet sealing, according to standard EN14470-1
- Air inlet and outlet with certified fire dampers closing ducts when the temperature is higher than 70 °C according to standard DIN 4102-6
- Prearrangement for ventilation through a Ø100 mm flange for an external connection or a filtering ventilation system (see the chapter on ventilation)
- Door closing and locking system allowing keeping the doors open and closing them automatically in case of ambient temperature higher than 50 °C
- Spark resistant hinge ensuring a perfect door solidity
- Cabinet equipped with earthing
- Leveling jacks
- Door key lock
- 3 stainless steel shelves whose height can be adjusted, 1 retention tray with grid (high model with 1 door)
- Shelf fastening on steel eyelets excluding all risks of sparks
- Shelves tested to fire
- ISO 3864: Pictogram signalling
- Certified as fire-resistant for **90 minutes** (30 minutes for the Safety Fire Case model), according to standard **EN14470-1 BV (Buerau Veritas)**

→ SERIES EFOMY11 RADIO

CODE	DESCRIPTION	EXTERNAL DIMENSIONS (WxDxH) mm	INTERNAL DIMENSIONS (WxDxH) mm	INTERNAL EQUIPMENT	STORAGE CAPACITY*	Weight (kg)
K89074	Cabinet series EFOMY11 RADIO with 1 door	595x600x1950	490x440x1540	3 stainless steel shelves (max load 60 KG evenly distributed) + 1 retention tray with stainless steel grid (capacity 20 Litres)	60 / 80	350
K89075	Underbench cabinet series EFOMY11 RADIO with 1 door	595x600x620	490x440x510	1 retention tray with stainless steel grid (capacity 20 Litres)	15/20	150
K89076	Safety Fire Case RADIO	340x340x400	200x200x265	1 stainless steel retention tray	4	45

*Approximate capacity in bottles holding 1 litre per cabinet

→ INTERNAL EQUIPEMENT (optional)

CODE	DESCRIPTION	DIMENSIONS (WxDxH) mm	RETENTION VOLUME (LITRES)	STORAGE CAPACITY*
RADIORIP60MY11	Additional stainless steel shelf for cabinet radio with 1 door	490x420x39	7	15/20
RADIOUBRIP60MY11	Additional stainless steel shelf for underbench cabinet radio with 1 door	490x420x39	7	15/20
K89033	External carbon dioxide fire-extinguisher with automatic thermal tripping (62 °C)	Ø90x280	-	-
K89132	Wheeled carriage to transport the Safety Fire Case	-	-	-

*Approximate capacity in bottles holding 1 litre

→ VENTILATION (optional)*

CODE	DESCRIPTION	DIMENSIONS (WxDxH) mm
DIAM125BP	Fresh air box with power cable and filter box - outlet diameter 100 mm	290x290x270
EOF100ABPMY11	Fresh air box ATEX with power cable and filter box - outlet diameter 100 mm	257x265x400
K89007	Activated charcoal filter for organic solvents (to replace at least twice a year)	235x110x15
GFKIT100	External connection kit (1 metre of hose diam 100 mm and 2 pipe clamps)	Ø100 - W 1000 mm

* To obtain the complete list of the connection accessories, see the chapter on ventilation of this catalogue and the current price list

SAFETY FIRE CASE

Certified according to EN14470-1 Type 30

Portable safety box to store 4 bottles (1L)
of inflammable liquids

**FIRE-RESISTANT
CERTIFIED**
30 minutes (TYPE 30)



✓
Ideal for storing small quantities.
Cheap implementation compared
with the regulations
on inflammable product storage

PORTABLE, PRACTICAL AND SAFE SAFETY FIRE CASE



SAFETY STORAGE CABINETS FOR INFLAMMABLES

→ TECHNICAL FEATURES:

- Completely made of an electrogalvanized steel plate with a thickness from 1 to 1.5 mm, cold bent - Grey RAL7031
- External finishing made of acidproof epoxy resin and passage through a thermal tunnel at 200 °C
- Cabinet isolation through some high density rock wool panels and some calcium sulphate panels
- Automatic cover closing when the ambient temperature exceeds 50 °C
- 30 mm thermo-expanding isolation seals that in case of temperature rise ensure a perfect box sealing, according to standard EN14470-1
- Optional carriage
- Side handles
- Clover with key lock
- 1 **stainless steel** retention tray
- ISO 3864: Pictogram signalling
- Certified as fire-resistant for 30 minutes, according to standard **EN14470-1 BV (Bureau Veritas)**

→ SAFETY FIRE CASE

CODE	DESCRIPTION	EXTERNAL DIMENSIONS (WxDxH) mm	INTERNAL DIMENSIONS (WxDxH) mm	INTERNAL EQUIPMENT	STORAGE CAPACITY*	Weight (kg)
K89130	Safety Fire Case Type 30	340x340x400	200x200x265	1 stainless steel retention tray (capacity 1.5 Litres)	4 bottles holding 1litre or 1 bottle holding 5 litres	18

*Capacité approximative en bouteilles de 1 litre par armoire

→ EQUIPMENT (optional)

CODE	DESCRIPTION	DIMENSIONS (WxDxH) mm	RETENTION VOLUME (LITRES)	STORAGE CAPACITY*
K89133	Wall mounting system	-	-	-
K89032	Wheeled carriage	-	-	-
K89131	Stainless steel retention tray	200x200x40	1,5	4 bottles holding 1 litre or 1 bottle holding 5 litres
TR/EFO	Pipe passage (chromatography)	Ø<2cm	-	-
K89033	External carbon dioxide fire-extinguisher with automatic thermal tripping (62°C)	Ø90x280	-	-

*Approximate capacity in bottles holding 1 litre

→ APPLICATION: CHROMATOGRAPHIE CPG / HPLC

- Solvent storage in a portable fire-resistant box and bound to the chromatographic chain through some tubing.
- The tubing is connected through a fire-resistant passage with a diameter < 2 cm located on the box cover.
- **Optional Chromatography:** Code: TR/EFO

Safety first
during your
chromatographic
manipulations



WASTE STORAGE TANK

EXACTA offers several solutions allowing safe collection of (flammable or not flammable) liquid wastes coming from the manipulations inside the laboratories.

→ HOW TO CHOOSE YOUR WASTE STORAGE TANK?

Our very big range of safety underbench cabinets allows offering several possible choices of waste storage tanks. The cabinet located below the working surface of the fume cabinet or underbench will be connected either to a basin or to a funnel:

- 1 - Choose your cabinet model from our underbench COMBISTORAGE range H620 mm according to the type of liquids to reject (fire-resistant cabinets or for chemicals)
- 2 - Choose the recovery and bottle filling level detection system as required.

A- Liquid recovery system with contact electronic control of the filling level (probe)

- Cabinet drilling for the discharge pipe passage
- The pipe will pass through the cabinet thanks to a firestop hole certified REI 180 for the use of inflammable products (EOF200MY11 / EOF200MY11E) and standard for acids/bases (EOF202MY11 / EOF202MY11E)
- Funnel with removable grid made of black HDPE allowing recovering contaminated liquids. - Jerrycans made of HDPE, capacity of 10 litres.
- Electronic level sensor assembled on velcro which can be fixed either on the jerrycan itself, or on the cabinet wall.
- Audible and visual alarm to be placed, for example, on an underbech cabinet back.
- The system will be equipped with a level probe with visual and audible alarm

CODE	TYPE OF COMBISTORAGE CABINETS	TYPE OF CONNECTION
EOF200MY11	INFLAMMABLE - H620 mm	BASIN
EOF202MY11	ACID / BASE - H620 mm	BASIN
EOF200MY11E	INFLAMMABLE - H620 mm	FUNNEL
EOF202MY11E	ACID / BASE - H620 mm	FUNNEL

Connection to an underbench funnel



- Safety funnel made of conductive HPDE. It is equipped with an earth system, and it is delivered with a cable and pliers. A removable sieve allows filtering some solids.
- The small funnel has a cover to close it when it is not used
- The big funnel is equipped with an automatic closing float

Connection to a basin under fume cabinet



B- Filling level control without contact by weighing

This system allows checking the liquid level contained in the bottle and controlling an alarm when the critical level is reached. A relay output (dry contact) is foreseen for this purpose. The system is equipped with an electronic control of the tare weight and of the high level to measure the precise level variations.

→ TECHNICAL FEATURES:

- Power: current network 230Vca / 50Hz
- Consumption: 100 mA
- Minimum capacity: 60 Kg
- Operating temperature : from -10 °C to 50 °C
- Plate dimensions: (WxDxH) 340x340x 340mm
- Overall dimensions: (WxDxH) 360x360x250 mm
- Degree of protection: IP55
- Relay detector alarm: 1A / 230Vca



Please contact us to ask for a customized solution

C - Filling level electronic control without contact through optical and acoustic signals

Contactless detection of the container filling level. The sensor sensitivity can be adjusted for the various thicknesses of the existing walls. The signalling box emits some optical and acoustic signals indicating that the filling level defined before has been reached. It is suitable for all non-conductive glass or plastic packaging. It is not suitable for stainless steel containers or for conductive plastic bottles.

- Easy assembly for all non-conductive glass or plastic packaging

- Reusable when the container is empty
- Possibility of monitoring simultaneously several containers
- All signal boxes are delivered with a power supply (110/230V)



Please contact us to ask for a customized solution

FIREPROOF CABINET accessories

Cooling system COLDY SYSTEM

The registered cooling system of fire-resistant safety cabinets

→ TECHNICAL FEATURES:

APPLICATION:

- Storage of products with a low flammability degree

PRINCIPLE:

- The system is made of a cryoscopic unit cooling a liquid up to -15 °C and, thanks to a pump, pushes it through a piping located inside the cabinet
- The heat exchange reduces the internal temperature with the possibility of adjusting it according to the specific needs of the products. So the internal temperature is reduced from 10 to 12 °C compared with the ambient temperature of the room
- A complementary safety is represented by an internal fire-extinguisher assembled on the piping, allowing releasing the liquid when the temperature reaches 68 °C, in the event of an internal fire
- An internal and external temperature control is possible thanks to the digital thermometer located on the cabinet door
- Temperature setpoint inside the cabinet : +20 °C (another temperature on request)

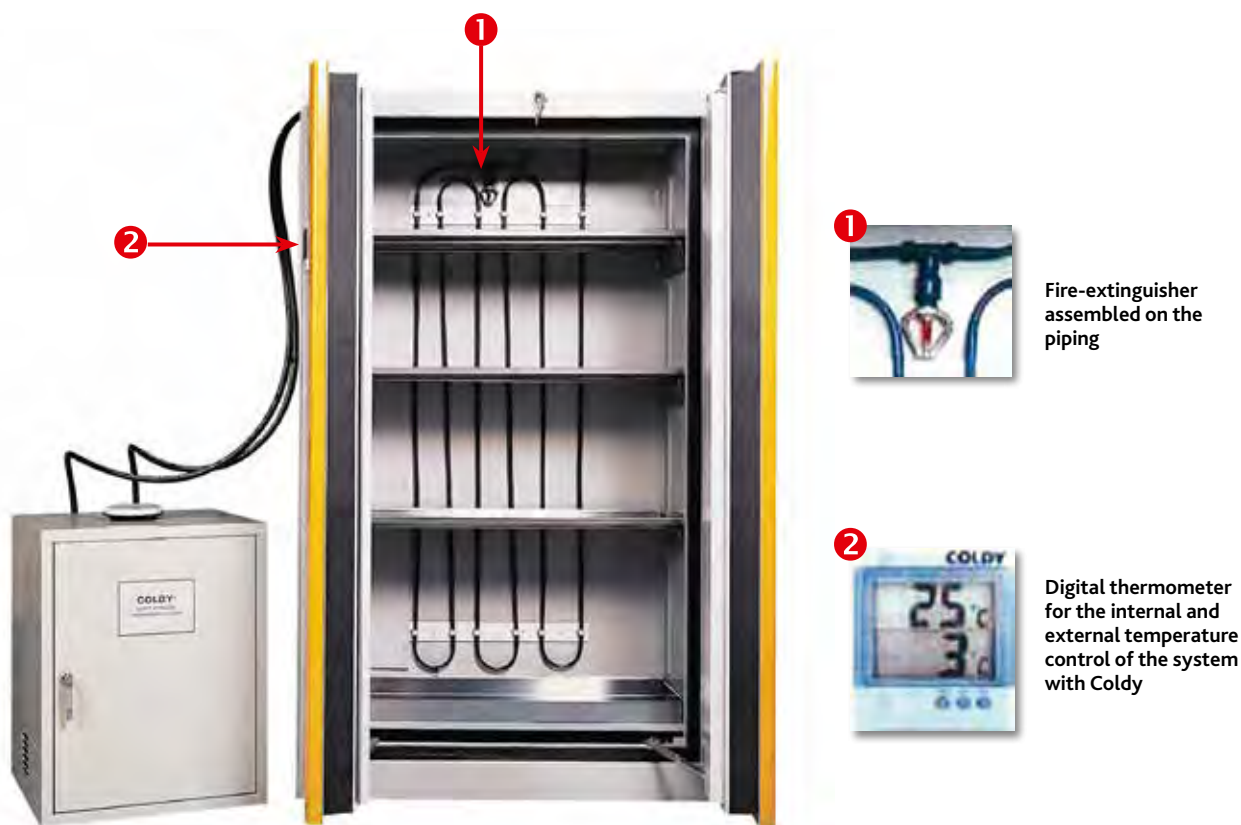

Fire-extinguisher assembled on the piping

Digital thermometer for the internal and external temperature control of the system with Coldy

CODE	DESCRIPTION
CSFR127	Internal cooling system of the cabinet for storing low flammability products for high cabinet with 1 door W600
CSFR129	Internal cooling system of the cabinet for storing low flammability products for high cabinet with 1 door W900
CSFR128	Internal cooling system of the cabinet for storing low flammability products for high cabinet with 2 doors
K89033	Internal carbon dioxide fire-extinguisher with automatic thermal tripping (62 °C)
AT100	Visual and audible alarm system, with telephone transmission with a digital thermostat equipped with a temperature probe (°C) inside the cabinet

Fire-extinguisher

→ TECHNICAL FEATURES:

- Automatic fire-extinguisher to be positioned inside or outside the cabinet
- Automatic tripping when the internal temperature of the cabinet exceeds 68 °C



K89033



Fire-extinguisher installed in a safety cabinet



Fastening system

Visual and audible alarm system with telephone transmission

→ TECHNICAL FEATURES:

- **Visual and audible alarm system with telephone transmission equipped with a T probe (°C) located inside the cabinet.** If the temperature setpoint is exceeded, an audible and visual alarm rings on the cabinet and calls one of the 24 prerecorded telephone numbers in the system.
- Temperature range: -40 / +90 °C
- Accuracy: +/- 1 °C
- Resolution: 1 °C



Base plate and wheel board

→ TECHNICAL FEATURES:

- **Base plate** with magnetized cover for pallet truck and **wheel board** to move easily the heaviest cabinets



Detail of the magnetized base plate

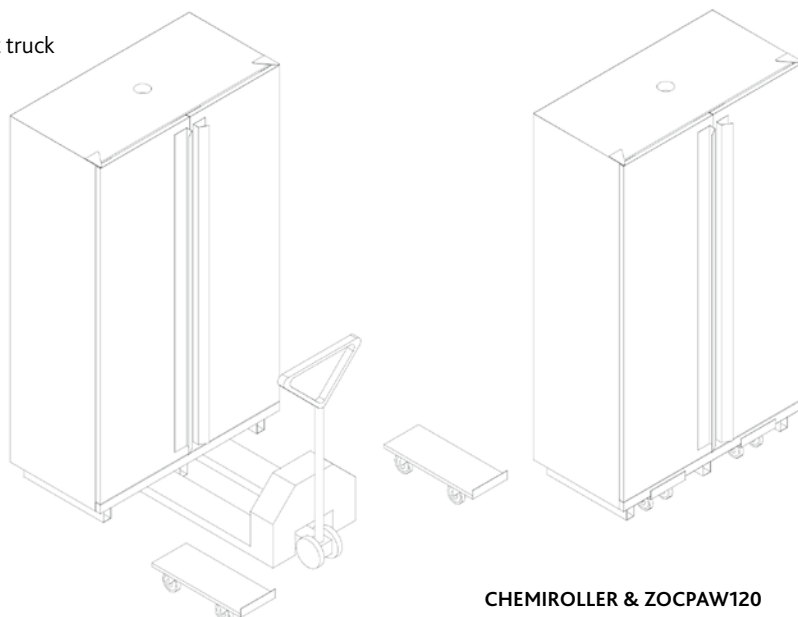

CHEMIROLLER & ZOCPAW120

Standard EN14470-2



The European harmonization with regard to the storage of chemicals and of gas cylinders has led to the evolution of the storage regulation of compressed gas cylinders.

That's why the new European standard EN14470-2 replaces standard DIN 12925-2.

➔ WHAT DOES THE STANDARD SAY?

EXACTA puts at your disposal all the certification documents of its cabinets

➔ FIRE RESISTANCE TEST

The introduction of standard EN 14470-2 increases the safety level all over Europe.

This standard prescribes that a cabinet for storing gas cylinders in a building must be fire-resistant.

The cabinet must be conceived and manufactured so that in case of fire its contents do not contribute to increase the risks or to spread fire for at least 15 minutes.

The cabinet is conceived so as to ventilate the internal part in case of reduced gas leakages.

➔ CLASSIFICATION

A safety cabinet for gas cylinders must be classified according to one of the following Types : G15, G30, G60 or G90 minutes.

It is the time for a temperature rise > de 50K (Temperature taken near the tightening plate of the gas cylinder valve).

The flammability class leaves a sufficient time to the staff to leave the area and to firefighters to enter it before the compressed gas cylinders become unstable.

➔ FIRE RESISTANCE

The fire resistance of the compressed gas cylinder storage cabinet must be established through a type test. This type test is carried out by heating the cabinet in an oven according to the time-temperature curve and by measuring the temperature increase on an empty gas cylinder surface located inside the cabinet. The temperature increase on the tightening plate surface of the cylinder valve must not exceed 50 K.

➔ CERTIFICATION

Each type of cabinet and each model must pass a fire test during which it will be tested. If a gap is detected in the measures above the tolerance limits set by the standard, the cabinet model must be tested again. **This test must be carried out by an independent approved body.** When the result of this test is obtained, a conformity certificate to standard EN14470-2 will be delivered and supplied with each cabinet model.

➔ MANUFACTURING

➔ VENTILATION

The cabinets must be equipped with some air inlet and outlet openings allowing connecting a drainage system

- if some inflammable gases that can maintain a fire are used, the cabinet air volume change will be of at least 10 times per hour

- if some toxic gases are used, the cabinet air volume change will be of at least 120 times per hour

The differential pressure must not exceed 150Pa. The ventilation system must keep a pressure inside the cabinet lower than the surrounding atmosphere.

➔ HOW TO HOLD THE GAS CYLINDER

A suitable system must be installed inside the cabinet, to prevent the gas cylinder from tilting.

➔ COMPRESSED GAS CYLINDER INSERTION AND WITHDRAWAL

The cabinet must be manufactured to allow inserting and withdrawing the cylinders with the utmost safety and with the minimum manual effort.

EXACTA provides for an access ramp on all its models.

Safety storage cabinets for gas cylinders

**FIRE-RESISTANT
CERTIFIED**
90 minutes (TYPE 90)

STORAGE CABINETS
FOR GAS CYLINDERS



→ GAS SUPPLY LINE INSTALLATION

The number of supply line passages through the cabinet wall or roof must be reduced to the minimum necessary with a maximum of three for each cylinder. The unused holes must be closed. We recommend making the three holes with a diameter of 10 mm each.

→ MARKING

A label must be installed on the front part of the cabinet and it must be readable indicating: the fire resistance class, that the doors must be kept closed, a safety pictogram must signal the presence of compressed gas cylinders, the manufacturer's brand, the model number, the manufacturing year and the serial number.

⇒ HOW DID THE FORMER STANDARD DIN 12925-2 CHANGE?

Due to the modifications on the gas cylinder safety cabinet tests, the former standard DIN12925-2 does not correspond any longer to the higher needs of standard NF EN 14470-2.

After the official issue of standard NF EN 14470-2, standard DIN 12925-2 has been officially replaced starting from December 2006.

⇒ MAXIMUM PROTECTION FOR SAFETY FIRST, WHY G90 ?

For several years in Germany as well as in Europe, the Type 90 classification, for the inflammable liquid storage in safety cabinets has been set as the standard. That's why we chose to offer you only the maximum safety standard G90. Therefore, the safety cabinets for storing under pressure gas cylinders G90 EXACTA meet the strictest manufacturing and test requirements of the new standard NF EN 14470-2.

Due to the lack of a classification for gas cylinder cabinets, the users on site had some different safety levels between the storage of inflammable liquids and of gas cylinders. Therefore, it can be expected that after the appearance of this standard several users will like to reach the same safety level in their gas cylinders of the one already reached for the storage of inflammable liquids thanks to safety cabinets resisting 90 minutes to fire (G90).

⇒ WHAT DOES THIS MEAN FOR THE USER?

- A use complying with the regulation
- A certification documentation for each safety cabinet bought
- A maximum safety for the users since in case of fire the staff can leave the building without any danger and the assistance and the firefighters can intervene to reach the cylinder storage place before any more serious fire breaks out because of gas combustion.



Series EBO

Certified according to EN14470-2



**FIRE-RESISTANT
CERTIFIED**
30 minutes (TYPE 30)

NEW!
Certification EN14470-2



B60G30



B120G30

→ TECHNICAL FEATURES:

- Completely made of an electrogalvanized steel plate with a thickness from 1 to 2 mm, cold bent
- External finishing made of acidproof epoxy resin and passage through a thermal tunnel at 200 °C
- Cabinet isolation through some high density rock wool panels and some calcium sulphate panels (DIN 4102)
- Internal finishing with melamine panels highly resistant to chemical and aggressive vapours
- Structure allowing replacing spare parts if necessary
- Automatic door closing when the ambient temperature exceeds 50 °C
- 30 mm thermo-expanding isolation seals that in case of temperature rise ensure a perfect cabinet sealing
- Air inlet and outlet with certified fire dampers closing ducts when the temperature exceeds 70 °C according to standard DIN 4102-6
- Prearrangement for ventilation through a Ø 100 mm flange for an external connection (see the chapter on ventilation)
- Closing system allowing keeping the door open in any position
- Spark resistant hinge ensuring a perfect door solidity
- Cabinet equipped with earthing
- Leveling jacks
- Gas pipe passage openings with a diameter of 12mm, located in the middle and on the upper part of the cabinet
- Door key lock
- Front side ramp made of galvanized steel to facilitate loading and manipulations
- 1 galvanized steel shelf for small gas cylinders
- Gas cylinder supports made of electrogalvanized steel delivered with a fixing chain
- Shelf fastening on aluminium eyelets excluding all risks of sparks
- ISO 3864 : pictogram signalling
- Certified as fire resistant for **30 minutes**, according to standard **EN14470-2 BV (Bureau Veritas)**

→ SERIES EBO

CODE	DESCRIPTION	EXTERNAL DIMENSIONS (WxDxH) mm	INTERNAL DIMENSIONS (WxDxH) mm	INTERNAL EQUIPMENT	STORAGE CAPACITY	Weight (kg)
B60G30	Cabinet series EBO with 1 door Type G30	595x600x1950	493x443x1540	1 galvanized steel shelf for small gas cylinders	1 gas cylinder Ø 26 cm or 2 cylinders Ø 21/23 cm	250
B120G30	Cabinet series EBO with 2 doors Type G30	1200x600x1950	1092x443x1540	1 galvanized steel shelf for small gas cylinders	3 gas cylinders Ø 26 cm or 4 cylinders Ø 21/23 cm	420

→ INTERNAL EQUIPMENT (optional)

CODE	DESCRIPTION	DIMENSIONS (WxDxH) mm	STORAGE CAPACITY
K89053	Additional shelf for small gas cylinder	430x330x250 (H barrière anti chute 30 mm)	1 small cylinder
K89033	External carbon dioxide fire-extinguisher with automatic thermal tripping (62 °C)	Ø 90x280	-

→ VENTILATION (optional)

CODE	DESCRIPTION	DIMENSIONS (WxDxH) mm
DIAM125BP	Fresh air box with power cable and filter box – outlet diameter 100 mm	290x290x270
EOF100ABPMY11	Fresh air box ATEX with power cable and filter box – outlet diameter 100 mm	270x260x430
K89007	Activated charcoal filter for organic solvents (to replace at least twice a year)	235x110x15
GFKIT100	External connection kit (1 metre of hose diam 100 mm and 2 pipe clamps)	Ø 100 - W 1000 mm

*To obtain the complete list of the connection accessories, see the chapter on ventilation of this catalogue and the current price list



Series EBO BASIC

Safety cabinets for the internal and external storage of gas cylinders



BBASIC60



BBASIC120

The cheap solution
to store
gas cylinders safely



BBASIC60G



BBASIC120G

→ TECHNICAL FEATURES:

- Completely made of an electrogalvanized steel plate (Skin passat) FE P01 with a thickness of 15/10 mm, cold bent and degreased
- External finishing made of epoxy resin and thermosetting powder and passage through a thermal tunnel at 200 °C
- Grey RAL7035
- Construction in one piece with jacks to level the cabinet
- Plain swing doors or with polycarbonate windows
- Door opening at 110°
- Safety closing with lock
- Door opening with an angle of 110°
- External hinge made of plastic resistant to corrosion
- Front side hinged ramp made of steel plate to facilitate loading and manipulations
- Bottle fixing chains
- ISO 3864: Pictogram signalling



→ SERIES EBO BASIC

CODE	DESCRIPTION	EXTERNAL DIMENSIONS (WxDxH) mm	INTERNAL DIMENSIONS (WxDxH) mm	INTERNAL EQUIPMENT	STORAGE CAPACITY	Weight (kg)
BBASIC60	Cabinet series EBO BASIC with 1 plain door	600x600x1950	530x540x1850	1 hinged ramp, chains	From 1 to 2 gas cylinders	70
BBASIC60G	Cabinet series EBO BASIC with 1 door with window	600x600x1950	530x540x1850	1 hinged ramp, chains	From 1 to 2 gas cylinders	70
BBASIC120	Cabinet series EBO BASIC with 2 plain doors	1200x600x1950	1130x540x1850	1 hinged ramp, chains	From 3 to 4 gas cylinders	125
BBASIC120G	Cabinet series EBO BASIC with 2 doors with window	1200x600x1950	1130x540x1850	1 hinged ramp, chains	From 3 to 4 gas cylinders	125





Series LED

Certified box for the external storage of compressed gas cylinders

→ TECHNICAL FEATURES:

- Manufacturing with steel panels welded to some enclosing side members to prevent the structure deflections
- Box with adjustable feet for fastening to the ground
- Possibility of filling the above-mentioned panels with sand or concrete, and then of fixing them
- Galvanization treatment on all components
- Polyurethane resin paint
- Modular roof made of corrugated cardboard fixed on a supporting basis made of painted steel
- PVC gutter to drain rainwater
- Doors with anti-intrusion grid equipped with a safety lock
- Equipped with continuous earthing for each piece (FARADAY CAGE)
- Extensible structure thanks to modules (the picture shows the model for 3 cylinders, see the drawings below)
- Openings to fix the modules
- Possibility of separating fuel and combustion agent
- No building permit is required
- Authorization from the Ministry of the interior
Certificate No. 3804/30/91



K89052

→ DOOR PROTECTION KIT

CODE	DESCRIPTION
KPAN01	1 door
KPAN02	2 doors



The logical, cheap and modular solution for storing your gas cylinders externally

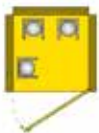

K89052 - LED3
For 3 gas cylinders
W960 x D880 x H2400mm
Weight: 262 Kg

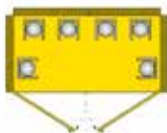

K89120 - LED6
For 6 gas cylinders
W1760 x D880 x H2400mm
Weight: 377 Kg

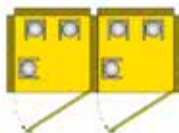

K89121 - LED3+3
For 3+3 gas cylinders
W1840 x D880 x H2400mm
Weight: 448 Kg

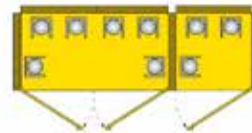

K89122 - LED6+3
For 6+3 gas cylinders
W2640 x D880 x H2400mm
Weight: 568 Kg

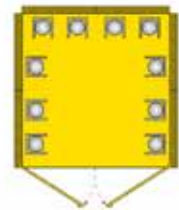

K89123 - LED10
For 10 gas cylinders
W1760 x D1680 x H2400mm
Weight: 550 Kg

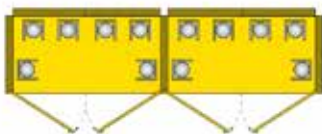

K89124 - LED6+6
For 6+6 gas cylinders
W3440 x D880 x H2400mm
Weight: 683 Kg

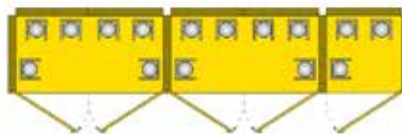

K89125 - LED6+6+3
For 6+6+3 gas cylinders
W4320 x D880 x H2400mm
Weight: 875 Kg

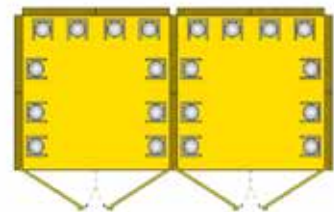

K89126 - LED10+10
For 10+10 gas cylinders
W3440 x D880 x H2400mm
Weight: 909 Kg

BOX FOR GAS CYLINDERS

STORAGE CABINETS FOR GAS CYLINDERS



PBOX912

→ **TECHNICAL FEATURES:**

- Swing door with security lock
- Roof made of galvanized steel
- Internal basis made of non-slip steel
- Earthing
- Internal chain and spring hook to fix the cylinders
- Already prepared to assemble modules
- Safety labelling included



PEDPB RAMP

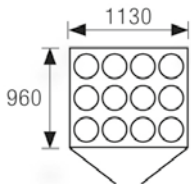

PBOX912
Box from 9 to 12 places
W1130 x D960 x H2100mm
Weight: 175 Kg

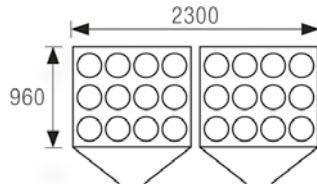

PBOX1824
Box from 18 to 24 places
W2300 x D960 x H2100mm
Weight: 350 Kg

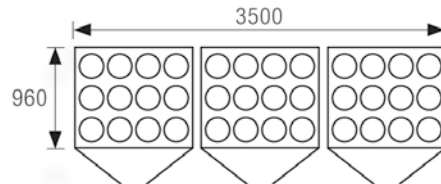

PBOX2436
Box from 24 to 36 places
W3500 x D960 x H2100mm
Weight : 520 Kg

Protect your equipment against the unauthorized people





Series COMBISTORAGE UNDERBENCH

Certified according to EN14470-1, EN61010 & EN14727



Our range of COMBISTORAGE underbench optimizes space in your laboratory!
The customized solution to replace your laboratory wooden or steel furniture with a combination of safety cabinets: for acids, bases and inflammables.

How to choose your combination?

- Measure the available space underbench
- If necessary, choose the suitable base plate for the available space
- Choose the cabinet models for acids/bases/inflammables according to your storage needs.

Each cabinet of the COMBISTORAGE underbench range can be combined on some base plates with different widths.

The different widths and heights of our cabinets allow you to find the solution to your storing problems in your laboratory

- Left door / right door / drawer opening
- 13 possible widths: from 400 to 1800 mm
- Base plates: H 80 mm
- All our models are available with 2 heights: 620 mm & 720 mm



In this way you can have a combination of Acids + Bases + inflammables on a unique base plate.



Modular and certified:
the solution for keeping and using hazardous products directly in the laboratory.

→ TECHNICAL FEATURES:

COMBISTORAGE FOR INFLAMMABLES

- Completely made of an electrogalvanized steel plate with a thickness from 1 to 1.5 mm, cold bent - Grey RAL7035
- External finishing made of acidproof epoxy resin and passage through a thermal tunnel at 200 °C
- Cabinet isolation through some high density rock wool panels and some calcium sulphate panels
- Internal finishing panels made of HPL highly resistant to chemical and aggressive vapours
- Structure allowing replacing spare parts if necessary
- Automatic door closing when the ambient temperature exceeds 50 °C
- 30 mm thermo-expanding isolation seals that in case of temperature rise ensure a perfect cabinet sealing, according to standard EN14470-1
- Air inlet and outlet with certified fire dampers closing ducts when the temperature is higher than 70 °C according to standard DIN 4102-6
- Prearrangement for ventilation through a Ø 100 mm flange for an external connection or a filtering ventilation system (see the chapter on ventilation)
- Spark resistant brass hinge ensuring a perfect door solidity
- Cabinet equipped with earthing
- Leveling jacks
- Door and drawer key lock
- Shelves made of **painted steel** or **stainless steel** whose height can be adjusted
- Shelf fastening on some aluminium eyelets excluding any spark risk
- Shelves tested to fire
- ISO 3864: Pictogram signalling
- Certified as resistant to fire for 90 minutes, according to standard **EN14470-1 BV (Bureau Veritas)**
- Certified as complying with standard **EN14727 BV (Bureau Veritas)**

COMBISTORAGE FOR ACIDS / BASES

- Completely made of an electrogalvanized steel plate with a thickness from 1 to 1.5 mm, cold bent - Grey RAL7035
- External finishing made of acidproof epoxy resin and passage through a thermal tunnel at 200 °C
- Internal finishing panels made of HPL highly resistant to chemical and aggressive vapours
- Structure allowing replacing spare parts if necessary
- Prearrangement for ventilation through a Ø 100 mm flange for an external connection or a filtering ventilation system (see the chapter on ventilation)
- Cabinet equipped with earthing
- Leveling jacks
- Door and drawer key lock
- Shelves made of **painted steel** or **stainless steel** whose height can be adjusted
- Shelf fastening on some eyelets
- ISO 3864: Pictogram signalling
- Certified as complying with standard **EN61010**
- Certified as complying with standard **EN14727 BV (Bureau Veritas)**



EOF611 + EOFZ110



EOF705C



EOFZ150 + EO705AC
+ EOF706C + EO704BC











Cabinet levelling.



Double isolation system preventing noxious vapours from coming out and hot air from entering in case of fire.







→ COMBISTORAGE UNDERBENCH FOR ACIDS / BASES - H 620 / H 720

TYPE OF OPENING	CODE FOR ACIDS	CODE FOR BASES	EXTERNAL DIMENSIONS (WxDxH) mm	INTERNAL DIMENSIONS (WxDxH) mm	STORAGE CAPACITY*	WEIGHT Kg
400 - RIGHT 	EO604AD	EO604BD	395 x 520 x 620	330 x 430 x 530	18	51
	EO704AD	EO704BD	395 x 520 x 720	330 x 430 x 630	18	54
400 - LEFT 	EO604AS	EO604BG	395 x 520 x 620	330 x 430 x 530	18	51
	EO704AS	EO704BG	395 x 520 x 720	330 x 430 x 630	18	54
400 - DRAWER 	EO604AC	EO604BT	395 x 520 x 620	330 x 430 x 530	9	51
	EO704AC	EO704BT	395 x 520 x 720	330 x 430 x 630	9	54
500 - RIGHT 	EO605AD	EO605BD	495 x 520 x 620	430 x 430 x 530	24	53
	EO705AD	EO705BD	495 x 520 x 720	430 x 430 x 630	24	56
500 - LEFT 	EO605AS	EO605BG	495 x 520 x 620	430 x 430 x 530	24	53
	EO705AS	EO705BG	495 x 520 x 720	430 x 430 x 630	24	56
500 - DRAWER 	EO605AC	EO605BT	495 x 520 x 620	430 x 430 x 530	12	53
	EO705AC	EO705BT	495 x 520 x 720	430 x 430 x 630	12	56
600 - RIGHT 	EO606AD	EO606BD	595 x 520 x 620	530 x 430 x 530	30	55
	EO706AD	EO706BD	595 x 520 x 720	530 x 430 x 630	30	58
600 - LEFT 	EO606AS	EO606BG	595 x 520 x 620	530 x 430 x 530	30	55
	EO706AS	EO706BG	595 x 520 x 720	530 x 430 x 630	30	58
600 - DRAWER 	EO606AC	EO606BT	595 x 520 x 620	530 x 430 x 530	15	55
	EO706AC	EO706BT	595 x 520 x 720	530 x 430 x 630	15	58

*Approximate capacity in bottles holding 1 litre
Standard colour Grey RAL7035, add « J » to the code for a yellow cabinet RAL1021. For stainless steel shelves, replace « V » with « X » in the item code. Base plate not compulsory, to be added if necessary.

→ COMBISTORAGE UNDERBENCH FOR ACIDS / BASES - H 620 / H 720

TYPE D'OUVERTURE	CODE ACIDS + BASES	EXTERNAL DIMENSIONS (WxDxH) mm	INTERNAL DIMENSIONS (WxDxH) mm	STORAGE CAPACITY*	WEIGHT Kg
1000 - 2 DOORS 	EO610AB	990 x 520 x 620	450 + 450 x 430 x 530	18 + 18	104
	EO710AB	990 x 520 x 720	450 + 450 x 430 x 630	18 + 18	110
1000 - DRAWER 	EO610ABC	990 x 520 x 620	450 + 450 x 430 x 530	9 + 9	104
	EO710ABC	990 x 520 x 720	450 + 450 x 430 x 630	9 + 9	110
1100 - 2 DOORS 	EO611AB	1090 x 520 x 620	490 + 490 x 430 x 530	24 + 24	104
	EO711AB	1090 x 520 x 720	490 + 490 x 430 x 630	24 + 24	114
1100 - DRAWER 	EO611ABC	1090 x 520 x 620	490 + 490 x 430 x 530	12 + 12	104
	EO711ABC	1090 x 520 x 720	490 + 490 x 430 x 630	12 + 12	114

*Approximate capacity in bottles holding 1 litre
 Standard colour Grey RAL7035, add « J » to the code for a yellow cabinet RAL1021. For stainless steel shelves, replace « V » with « X » in the item code.
 Base plate not compulsory, to be added if necessary.

CERTIFIED MULTI-RISK
 COMBISTORAGE
 CABINETS SERIES

→ BASE PLATES

CODE	DIMENSIONS (WxDxH) mm
EOFZ40	400 x 500 x 80
EOFZ50	500 x 500 x 80
EOFZ60	600 x 500 x 80
EOFZ80	800 x 500 x 80
EOFZ90	900 x 500 x 80
EOFZ100	1000 x 500 x 80
EOFZ110	1100 x 500 x 80
EOFZ120	1200 x 500 x 80
EOFZ140	1400 x 500 x 80
EOFZ150	1500 x 500 x 80
EOFZ160	1600 x 500 x 80
EOFZ170	1700 x 500 x 80
EOFZ180	1800 x 500 x 80



Retention shelves made of painted steel













EO706AD



EOF605C + EO606AD + base plate EOFZ110

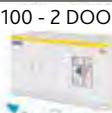
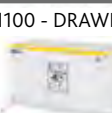

→ COMBISTORAGE UNDERBENCH FOR INFLAMMABLES TYPE 90 - H 620 / H 720

TYPE D'OUVERTURE	CODE FOR INFLAMMABLES TYPE 90	EXTERNAL DIMENSIONS (WxDxH) mm	INTERNAL DIMENSIONS (WxDxH) mm	STORAGE CAPACITY*	WEIGHT Kg
500 - RIGHT 	EOF605D	495 x 520 x 620	383 x 349 x 493	12	73
	EOF705D	495 x 520 x 720	383 x 349 x 593	12	78
500 - LEFT 	EOF605S	495 x 520 x 620	383 x 349 x 493	12	73
	EOF705S	495 x 520 x 720	383 x 349 x 593	12	78
500 - DRAWER 	EOF605C	495 x 520 x 620	383 x 349 x 493	12	73
	EOF705C	495 x 520 x 720	383 x 349 x 593	12	78
600 - RIGHT 	EOF606D	595 x 520 x 620	483 x 349 x 493	15	82
	EOF706D	595 x 520 x 720	483 x 349 x 593	15	87
600 - LEFT 	EOF606S	595 x 520 x 620	483 x 349 x 493	15	82
	EOF706S	595 x 520 x 720	483 x 349 x 593	15	87
600 - DRAWER 	EOF606C	595 x 520 x 620	483 x 349 x 493	15	82
	EOF706C	595 x 520 x 720	483 x 349 x 593	15	87
890 - 2 DOORS 	EOF 609	890 x 520 x 620	778 x 349 x 493	25	105
	EOF 709	890 x 520 x 720	778 x 349 x 593	25	110
890 - DRAWER 	EOF 609C	890 x 520 x 620	778 x 349 x 493	25	105
	EOF 709C	890 x 520 x 720	778 x 349 x 593	25	110
1000 - 2 DOORS 	EOF610	990 x 520 x 620	878 x 349 x 493	27	118
	EOF710	990 x 520 x 720	878 x 349 x 593	27	125
1000 - DRAWER 	EOF610C	990 x 520 x 620	878 x 349 x 493	27	118
	EOF710C	990 x 520 x 720	878 x 349 x 593	27	125
1100 - 2 DOORS 	EOF611	1090 x 520 x 620	978 x 349 x 493	30	134
	EOF711	1090 x 520 x 720	978 x 349 x 593	30	139
1100 - DRAWER 	EOF611C	1090 x 520 x 620	978 x 349 x 493	30	134
	EOF711C	1090 x 520 x 720	978 x 349 x 593	30	139

→ BASE PLATES

CODE	DIMENSIONS (WxDxH) mm
EOFZ40	400 x 500 x 80
EOFZ50	500 x 500 x 80
EOFZ60	600 x 500 x 80
EOFZ80	800 x 500 x 80
EOFZ90	900 x 500 x 80
EOFZ100	1000 x 500 x 80
EOFZ110	1100 x 500 x 80
EOFZ120	1200 x 500 x 80
EOFZ140	1400 x 500 x 80
EOFZ150	1500 x 500 x 80
EOFZ160	1600 x 500 x 80
EOFZ170	1700 x 500 x 80
EOFZ180	1800 x 500 x 80



Retention tray with painted steel grid.

*Approximate capacity in bottles holding 1 litre.

Standard colour Grey RAL7035, add « J » to the code for a yellow cabinet RAL1021. For stainless steel shelves, replace « V » with « X » in the item code.

Base plate not compulsory, to be added if necessary.

→ INTERNAL EQUIPMENT (optional)

CODE	DESCRIPTION	DIMENSIONS (WxDxH) mm	RETENTION VOLUME (LITRES)	STORAGE CAPACITY*
SHELVES FOR COMBISTORAGE INFLAMMABLES - shelves tested to fire				
RIPF50V	Additional shelf made of painted steel for cabinet with 1 door W500	380x330x30	4	12
RIPF50X	Additional shelf made of stainless steel for cabinet with 1 door W500	380x330x30	4	12
RIPF60V	Additional shelf made of painted steel for cabinet with 1 door W600	480x330x30	5	15
RIPF60X	Additional shelf made of stainless steel for cabinet with 1 door W600	480x330x30	5	15
RIPF100V	Additional shelf made of painted steel for cabinet with 2 doors W1000	875x330x30	9	27
RIPF100X	Additional shelf made of stainless steel for cabinet with 2 doors W1000	875x330x30	9	27
RIPF110V	Additional shelf made of painted steel for cabinet with 2 doors W1100	975x330x30	10	30
RIPF110X	Additional shelf made of stainless steel for cabinet with 2 doors W1100	975x330x30	10	30
SHELVES FOR COMBISTORAGE ACIDS				
RIPCS140V	Additional shelf made of painted steel for cabinet with 1 door W400	325x420x30	4	9
RIPCS150V	Additional shelf made of painted steel for cabinet with 1 door W500	452x420x30	6	12
RIPCS160V	Additional shelf made of painted steel for cabinet with 1 door W600	525x420x30	7	15
RIPCS100V	Additional shelf made of painted steel for cabinet with 2 doors W1000 (for acids)	385x420x30	5	9
RIPCS110V	Additional shelf made of painted steel for cabinet with 2 doors W1100 (for acids)	485x420x30	6	12
SHELVES FOR COMBISTORAGE BASES				
RIPCS140X	Additional shelf made of stainless steel for cabinet with 1 door W400	325x420x30	4	9
RIPCS150X	Additional shelf made of stainless steel for cabinet with 1 door W500	452x420x30	6	12
RIPCS160X	Additional shelf made of stainless steel for cabinet with 1 door W600	525x420x30	7	15
RIPCS100X	Additional shelf made of stainless steel for cabinet with 2 doors W1000 (for bases)	385x420x30	5	9
RIPCS110X	Additional shelf made of stainless steel for cabinet with 2 doors W1100 (for bases)	485x420x30	6	12
ACCESSORIES				
AT100	Visual and audible alarm system with telephone transmission equipped with a digital thermostat with a T probe (°C) inside the cabinet	-	-	-
TIM24	Daily counter	-	-	-
K89033	Internal carbon dioxide fire-extinguisher with automatic thermal tripping (62 °C)	Ø90x280	-	-
K89590	Set of 4 wheels (2 self-locking) for underbench cabinets (H105 mm)	(H105mm)	-	-
K89590/10	Set of 4 wheels (2 self-locking) for underbench cabinets (H100 mm)	(H100mm)	-	-

*Approximate capacity in bottles holding 1 litre

→ VENTILATION (optional)

CODE	DESCRIPTION	DIMENSIONS (WxDxH) mm
EOF100BPMY11	Fresh air box with power cable and filter box - outlet diameter 100 mm	270x260x430
EOF100ABPMY11	Fresh air box ATEX with power cable and filter box - outlet diameter 100 mm	270x260x430
K89007	Activated charcoal filter (to replace at least twice a year)	235x110x15
F100	Ø 100mm connecting flange for motor EOF100BPMY11 (compulsory to ventilate the underbench cabinets)	Ø100 mm
KIT2A	Connection kit for TWO cabinets (flexible sheath, tee, clamps) (factory assembly)	sortie Ø100 mm
KIT3A	Connection kit cabinets (flexible sheath, tee, clamps) (factory assembly)	sortie Ø100 mm
GFKIT100	External connection kit (1 metre of hose diam. 100 mm and 2 clamps)	Ø100 - L1000 mm
CFNUB	Certified filter unit according to standard NFX15-211 for underbench cabinets, equipped with wheels, 2 ventilation outlets, with visual and audible alarm	400x500x650
CFNUBLH	Filter unit manufactured according to standard NFX15-211 for underbench cabinets, equipped with wheels, 2 ventilation outlets	400x500x650
EOAS	Activated charcoal filter for solvents (prefilter included)	510x405x60
EOBE	Activated charcoal filter for acids (prefilter included)	510x405x60
EOMP	Activated charcoal filter for solvents and acids (prefilter included)	510x405x60
EOPF	Prefilter	510x405x15

* To obtain the complete list of the connection accessories, see the chapter on ventilation of this catalogue and the current price list



Series COMBISTORAGE 2C

Certified according to EN14470-1, EN61010 & EN14727

Modular solutions
to the Laboratory Service



E0260



E0360



E0360C

→ TECHNICAL FEATURES:

- Completely made of stainless steel electrogalvanized AISI304 with a thickness from 1 to 1.5 mm, cold bent - Grey RAL7035
- External finishing made of acidproof epoxy resin and passage through a thermal tunnel at 200 °C

Two separate compartments (high and low), for inflammables and acids/bases:

COMPARTMENT TYPE 90 FOR INFLAMMABLES

- Cabinet isolation through some high density rock wool panels and some calcium sulphate panels for the inflammable compartment
- Internal finishing with melamine panels highly resistant to chemical and aggressive vapours
- Structure allowing replacing spare parts if necessary
- Automatic door closing when the ambient temperature exceeds 50 °C
- 30 mm thermo-expanding isolation seals that in case of temperature rise ensure a perfect cabinet sealing, according to standard EN14470-1
- Air inlet and outlet with certified fire dampers closing ducts when the temperature exceeds 70 °C according to standard DIN 4102-6
- Closing system allowing keeping the door open in any position and closing it automatically in case of ambient temperature higher than 50 °C
- Spark resistant hinge ensuring a perfect door solidity

- Possibility of having a cabinet with door or drawer according to the models
- Key lock
- Equipped with a retention tray with grid made of painted steel serving as shelf

COMPARTMENT FOR ACIDS/BASES

- Internal finishing with melamine panels highly resistant to chemical and aggressive vapours
- Structure allowing replacing spare parts if necessary
- Door opening with an angle higher than 110°
- Key lock
- Retention shelf made of painted steel and stainless steel whose height can be adjusted
- Cabinet equipped with an integrated ventilation system with external connection or prearranged for ventilation through a Ø100 mm flange
- Cabinet equipped with earthing
- Leveling jacks
- ISO 3864: Pictogram signalling
- Cabinets certified according to standards EN14470-1, EN61010 and EN14727
- Certified as fire resistant for 90 minutes

→ SERIE COMBISTORAGE 2C

CODE	DESCRIPTION	EXTERNAL DIMENSIONS (WxDxH) mm	INTERNAL DIMENSIONS (WxDxH) mm	INTERNAL EQUIPMENT	STORAGE CAPACITY*	Weight kg
EO260	Combistorage without ventilation system Acids/Bases: door Inflammables: door	595x600x165	Acids/Bases: 530x430x630 Inflammables: 483x349x593	Acids/Bases: 1 shelf made of painted steel and 1 shelf made of stainless steel (max load 60 KG evenly distributed) Inflammables: 1 retention tray with grid made of painted steel	30 (Acids/Bases) 15 (Inflammables)	145
EO260C	Combistorage without ventilation system Acids/Bases: door Inflammables: drawer	595x600x165	Acids/Bases: 530x430x630 Inflammables: 483x349x593	Acids/Bases: 1 shelf made of painted steel and 1 shelf made of stainless steel (max load 60 KG evenly distributed) Inflammables: 1 retention tray with grid made of painted steel	30 (Acids/Bases) 15 (Inflammables)	145
EO360	Combistorage with ventilation system and filter Acids/Bases: door Inflammables: door	595x600x165	Acids/Bases: 530x430x630 Inflammables: 483x349x593	Acids/Bases : 1 shelf made of painted steel and 1 shelf made of stainless steel (max load 60 KG evenly distributed) Inflammables : 1 retention tray with grid made of painted steel	30 (Acids/Bases) 15 (Inflammables)	170
EO360C	Combistorage with ventilation system and filter Acids/Bases: door Inflammables: drawer	595x600x165	Acids/Bases: 530x430x630 Inflammables: 483x349x593	Acids/Bases : 1 shelf made of painted steel and 1 shelf made of stainless steel (max load 60 KG evenly distributed) Inflammables : 1 retention tray with grid made of painted steel	30 (Acids/Bases) 15 (Inflammables)	170

*Approximate capacity in bottles holding 1 litre per cabinet

→ INTERNAL EQUIPMENT (optional)

CODE	DESCRIPTION	DIMENSIONS (WxDxH) mm	RETENTION VOLUME (LITRES)	STORAGE CAPACITY*
RIPCS260V	Additional shelf made of painted steel for acid compartment	530x430x39	7	15
RIPCS260X	Additional shelf made of stainless steel for basis compartment	530x430x39	7	15
RIPF60V	Additional shelf made of painted steel for inflammable compartment	493x420x39	7	15
RIPF60X	Additional shelf made of stainless steel for inflammable compartment	493x420x39	7	15
ZOCPAL60	Base plate for pallet truck W60	595x600x110	-	-
CHEMIROLL	Wheel board to move cabinets (the code ZOCPAL is necessary)	-	-	-
AT100	Visual and audible alarm system with telephone transmission equipped with a digital thermostat with a T probe (°C) inside the cabinet	-	-	-
TIM24	Daily counter	-	-	-
K89033	Internal carbon dioxide fire-extinguisher with automatic thermal tripping (62 °C)	Ø90x280	-	-

*Approximate capacity in bottles of 1 litre

→ VENTILATION (optional)

CODE	DESCRIPTION	DIMENSIONS (WxDxH) mm
EOF100	Fresh air box with power cable - outlet diameter 100 mm	257x265x400
EOF100A	Fresh air box ATEX with power cable - outlet diameter 100 mm	257x265x400
BP100MY11	Filter box	-
K89007	Activated charcoal filter (to replace at least twice a year)	235x110x15
GFKIT100	External connection kit (1 metre of hose diam 100 mm and 2 clamps)	Ø 100 - W1000 mm
CFN	Fresh air box with molecular filtration according to standard NFX15-211 (only for models EO260 & EO260C), with visual and audible alarm	550x500x220
CFNLH	Molecular filtration box manufactured according to standard NFX15-211 (only for models EO260 & EO260C)	550x500x220
EOAS	Activated charcoal filter for solvents (prefilter included)	510x405x60
EOBE	Activated charcoal filter for acids (prefilter included)	510x405x60
EOMP	Activated charcoal filter for solvents and acids (prefilter included)	510x405x60
EOPF	Prefilter	510x405x15

*To obtain the complete list of the connection accessories, see the chapter on ventilation of this catalogue and the current price list

CERTIFIED MULTI-RISK
COMBISTORAGE
CABINETS SERIES



Series COMBISTORAGE 3C AND 4C

Certified according to EN14470-1, EN61010 & EN14727



EO343MY11



EO342MY11



EO344MY11+CFN

Separate storage of inflammables (EN14470-1) and chemicals (EN61010-1)

→ TECHNICAL FEATURES:

- Completely made of an electrogalvanized steel plate with a thickness from 1 to 1.5 mm, cold bent - Grey RAL7035
- External finishing made of acidproof epoxy resin and passage through a thermal tunnel at 200 °C
- Cabinet prearranged for ventilation
- Cabinet equipped with earthing
- Leveling jacks
- ISO 3864: Pictogram signalling
- Certified as fire resistant for **90 minutes**
- Cabinets certified according to standards: **EN14470-1, EN61010 and EN14727**

COMPARTMENT TYPE 90 FOR INFLAMMABLES

- Cabinet isolation through some high density rock wool panels and some calcium sulphate panels for the inflammable compartment
- Internal finishing with melamine panels highly resistant to chemical and aggressive vapours
- Structure allowing replacing spare parts if necessary
- Automatic door closing when the ambient temperature exceeds 50 °C
- 30 mm thermo-expanding isolation seals that in case of temperature rise ensure a perfect cabinet sealing, according to standard EN14470-1
- Air inlet and outlet with fire dampers closing ducts when the temperature is higher than 70°C according to standard DIN 4102-6
- **Door closing and locking system allowing keeping doors open** and closing them automatically in case of ambient temperature higher than 50 °C
- Spark resistant hinge ensuring a perfect door solidity

- Key lock
- Equipped with three retention shelves and with a retention tray with grid made of painted steel serving as shelf

MULTI-RISK COMPARTMENT FOR UNINFLAMMABLES

- Made of two or three compartments with painted plain or glazed doors
- Cabinet body made of galvanized steel

Compartment for «Acids»

- Two retention shelves made of painted steel, whose height can be adjusted
- Door opening with an angle higher than 110°
- Key lock
- Complies with standard EN 61010-1 & CEI 66-5
- Storage capacity: 40 bottles holding 1L (20L per shelf)

Compartment for «Bases»

- Two retention shelves made of stainless steel, whose height can be adjusted
- Door opening with an angle higher than 110°
- Key lock
- Complies with standards EN 61010-1 & CEI 66-5
- Storage capacity: 40 bottles holding 1L (20L per shelf)

Compartment for «Toxics»

- Two retention shelves made of painted steel, whose height can be adjusted
- Ouverture des portes avec un angle de plus de 110°
- Key lock
- Complies with standards EN 61010-1 & CEI 66-5
- Storage capacity: 40 bottles holding 1L (20L per shelf)

→ SERIES COMBISTORAGE 3C AND 4C

CODE	DESCRIPTION	EXTERNAL DIMENSIONS (WxDxH) mm	INTERNAL DIMENSIONS (WxDxH) mm	INTERNAL EQUIPMENT	STORAGE CAPACITY*	Weight kg
EO343MY11	Combistorage 3 Inflammables: 1 plain door Acids/Bases: 2 compartments, 2 plain doors	1200x600x1950	Inflammables: 496x446x1540 Acids/Bases: 2 x 590x500x880	Acids: 2 shelves made of painted steel Bases: 2 shelves made of stainless steel Inflammables: 3 shelves and 1 retention tray with grid made of painted steel (max load 60 KG evenly distributed)	40+40 (Acids/Bases) 120 (Inflammables)	310
EO342MY11	Combistorage 4 Inflammables: 1 plain door Acids/Bases: 3 compartments, 3 plain doors	1200x600x1950	Inflammables: 496x446x1540 Acids/Bases/ Toxics: 3 x 590x500x880	Acids: 2 shelves made of painted steel Bases: 2 shelves made of stainless steel Toxics: 2 shelves made of painted steel Inflammables: 3 shelves and 1 retention tray with grid made of painted steel (max load 60 KG evenly distributed)	40+40+40 (Acids/Bases/ Toxics) 120 (Inflammables)	313
EO344MY11	Combistorage 3 Inflammables: 1 plain door Acids/Bases: 3 compartments, 3 glazed doors	1200x600x1950	Inflammables: 496x446x1540 Acids/Bases/ Toxics: 3 x 590x500x880	Acids: 2 shelves made of painted steel Bases: 2 shelves made of stainless steel Toxics: 2 shelves made of painted steel Inflammables: 3 shelves and 1 retention tray with grid made of painted steel (max load 60 KG evenly distributed)	40+40+40 (Acids/Bases/ Toxics) 120 (Inflammables)	315

*Approximate capacity in bottles holding 1 litre per cabinet

→ INTERNAL EQUIPMENT (optional)

CODE	DESCRIPTION	DIMENSIONS (WxDxH) mm	RETENTION VOLUME (LITRES)	STORAGE CAPACITY*
RIP60VMY11	Additional shelf made of painted steel for inflammable compartment	493x420x39	7	30
RIP60XMY11	Additional shelf made of stainless steel for inflammable compartment	493x420x39	7	30
RIPCS60	Fixed shelf made of painted steel for acid or toxic compartment	485x545x34	9	35
RIPX60	Fixed shelf made of stainless steel for basis compartment	485x545x34	9	35
RIP60SC	« Sliding shelf »: sliding system to be added to the shelf (only for cabinets with 1 door or cabinets with 2 compartments)	-	-	-
VACS60	Retention tray made of painted steel for acid or toxic compartment	485x545x70	18	35
VA60PP	Retention tray made of polypropylene	485x545x70	18	35
COPCS60	Grid made of painted steel	485x545	-	35
PS50SMY11	Replacing system with closing thermal fuse - left door	-	-	-
ZOCPAL120	Base plate for pallet truck W120	595x600x110	-	-
CHEMIROLL	Wheel board to move the cabinets (the code ZOCPAL is necessary)	-	-	-
AT100	Visual and audible alarm system with telephone transmission equipped with a digital thermostat with a T probe (°C) inside the cabinet	-	-	-
TIM24	Compteur journalier	-	-	-
K89033	Internal carbon dioxide fire-extinguisher with automatic thermal tripping (62 °C)	Ø90x280	-	-

*Approximate capacity in bottles holding 1 litre

→ VENTILATION (en option)

CODE	DESCRIPTION	DIMENSIONS (WxPxH) mm
EOF120MY11	Suction system for Combistorage 3C and 4C - outlet Ø: 100 mm	1200x600x 300
BP100MY11	Filter box	-
K89007	Activated charcoal filter for inflammable compartment - (to replace at least twice a year)	235x110x15
K89021	Activated charcoal filter for acid/basis/toxic compartment - (to replace at least twice a year)	300x240x15
GFKIT100	External connection kit (1 metre of flexible people diam 100 mm and 2 clamps)	Ø100 - W1000 mm
CFN	Fresh air box with molecular filtration according to standard NFX15-211, with visual and audible alarm	550x500x220
CFNLH	Molecular filtration box manufactured according to standard NFX15-211	550x500x220
ADMY11CFN	Adapter for CFN box	850 x 500 x 80
EOAS	Activates charcoal filter for solvents (prefilter included)	510x405x60
EOBE	Activated charcoal filter for acids (prefilter included)	510x405x60
EOMP	Activated charcoal filter for solvents and acids (prefilter included)	510x405x60
EOPF	Prefilter	510x405x15

*To obtain the complete list of the connection accessories, see the chapter on ventilation of this catalogue and the current price list

CERTIFIED MULTI-RISK
COMBISTORAGE
CABINETS SERIES



Series COMBISTORAGE 120 FIRE TYPE 90

Certified according to EN14470-1 & EN14727



EOF232/4C



EOF232/2C



EOF232/3C

The maximum safety for all your products.
Partitioned cabinet completely fire-resistant TYPE90

→ TECHNICAL FEATURES:

- Completely made of a galvanized steel plate with a thickness from 1 to 1.5 mm, cold bent - Grey RAL7035
- External finishing made of acidproof epoxy resin and passage through a thermal tunnel at 200 °C
- Cabinet isolation through some high density rock wool panels and some calcium sulphate panels
- Internal finishing with melamine panels highly resistant to chemical and aggressive vapours
- Structure allowing replacing spare parts if necessary
- Automatic door closing when the ambient temperature exceeds 50 °C
- 30 mm thermo-expanding isolation seals that in case of temperature rise ensuring a perfect cabinet sealing, according to standard EN14470-1
- Air inlet and outlet with certified fire dampers closing ducts when the temperature exceeds 70 °C according to standard DIN 4102-6
- Prearrangement for ventilation through a Ø 100mm flange for an external connection or a filtering ventilation system (see the chapter on ventilation)
- **Door closing and locking system allowing keeping the doors open** and closing them automatically if the ambient temperature is higher than 50 °C
- Spark resistant hinge ensuring a perfect door solidity
- Cabinet equipped with earthing
- Leveling jacks
- Door key lock

- Shelves made of painted steel or of stainless steel whose height can be adjusted
- Shelf fastening on some aluminium or copper eyelets excluding any spark risk
- Shelves tested to fire
- ISO 3864: Pictogram signalling
- Cabinets certified according to standards EN14470 and EN14727

INTERNAL COMPARTMENTS to store various families of chemicals:

- Separation by means of panels made of HPL with a thickness of 18 mm coated with thermo-expanding seals (possibility of having up to 3 compartments and of customizing compartments - please contact us)

Compartment for «Inflammables»

- 3 retention shelves whose height can be adjusted and 1 retention tray with grid made of epoxy painted steel

Compartment for «Toxics»

- 1 retention shelf whose height can be adjusted made of epoxy painted steel

Compartment for «Acids»

- 2 retention shelves whose height can be adjusted made of epoxy painted steel

Compartment for «Bases»

- 2 retention shelves whose height can be adjusted made of stainless steel

→ SERIES COMBISTORAGE FIRE 120 TYPE 90

CODE	DESCRIPTION	EXTERNAL DIMENSIONS (WxDxH) m	INTERNAL DIMENSIONS (WxDxH) mm	INTERNAL EQUIPMENT	STORAGE CAPACITY*	Weight kg
EOF232/2C	Cabinet series COMBISTORAGE T90 with 2 doors 2 compartments	1200x600x1950	540+540x446x1540	COMPARTMENT FOR INFLAMMABLES: 3 shelves made of painted steel + 1 retention tray with grid COMPARTMENT FOR ACIDS/BASES: 2 shelves made of painted steel (max load 60 KG evenly distributed)	180	378
EOF232/3C	Cabinet series COMBISTORAGE T90 with 2 doors 3 compartments	1200x600x1950	540+540x446x1540 (760+760 for compartment for acids/bases)	COMPARTMENT FOR INFLAMMABLES: 3 shelves made of painted steel + 1 retention tray with grid COMPARTMENT FOR ACIDS: 2 shelves made of painted steel COMPARTMENT FOR BASES: 2 shelves made of stainless steel (max load 60 KG evenly distributed)	240	378
EOF232/4C	Cabinet series COMBISTORAGE T90 with 2 doors 4 compartments	1200x600x1950	540+540x446x1540 (600+600+300 for compartment for acids/bases/toxics)	COMPARTMENT FOR INFLAMMABLES: 3 shelves made of painted steel + 1 retention tray with grid COMPARTMENT FOR ACIDS: 2 shelves made of painted steel COMPARTMENT FOR BASES: 2 shelves made of stainless steel COMPARTMENT FOR TOXICS: 1 shelf made of painted steel (max load 60 KG evenly distributed)	270	378

*Approximate capacity in bottles holding 1 litre per cabinet

→ INTERNAL EQUIPMENT (optional)

CODE	DESCRIPTION	DIMENSIONS (WxDxH) mm	RETENTION VOLUME (LITRES)	STORAGE CAPACITY*
RIP60VMY11	Additional shelf made of painted steel for inflammable compartment	493x420x39	7	30
RIP60XMY11	Additional shelf made of stainless steel for inflammable compartment	493x420x39	7	30
EOF85P	Additional shelf made of stainless steel for basis compartment	493x420x39	7	30
EOF45P	Additional shelf made of epoxy painted steel for acid & toxic compartment	493x420x39	7	30
PS50SMY11	Groom with thermal fuse - left door	-	-	-
PS50MY11	Groom with thermal fuse - right door	-	-	-
ZOCPAL120	Base plate for pallet truck W120	1200x600x110	-	-
CHEMIROLL	Wheel board to move the cabinets (the code ZOCPAL is necessary)	-	-	-
AT100	Visual and audible alarm system with telephone transmission equipped with a digital thermostat with a T probe (°C) inside the cabinet	-	-	-
TIM24	Daily counter	-	-	-
K89033	Internal carbon dioxide fire-extinguisher with automatic thermal tripping (62 °C)	Ø90x280	-	-
AT100	Visual and audible alarm system with telephone transmission equipped with a digital thermostat with T probe (°C) inside the cabinet	-	-	-
TIM24	Daily counter	-	-	-
K89033	Internal carbon dioxide fire-extinguisher with automatic thermal tripping (62 °C)	Ø90x280	-	-

*Approximate capacity in bottles holding 1 litre

→ VENTILATION (optional)

CODE	DESCRIPTION	DIMENSIONS (WxDxH) mm
DIAM125BP	Fresh air box with power cable and filter box - outlet diameter 100 mm	290x290x270
EOF100ABPMY11	Fresh air box ATEX with power cable and filter box - outlet diameter 100 mm	270x260x430
K89007	Activated charcoal filter (to replace at least twice a year)	235x110x15
GFKIT100	External connection kit (1 metre of hose diam 100 mm and 2 clamps)	Ø 100 - W 1000 mm
CFN	Fresh air box with molecular filtration according to standard NFX15-211, with visual and audible alarm	550x500x220
CFNLH	Molecular filtration box manufactured according to standard NFX15-211	550x500x220
ADCFNMY11	Adapter for CFN box	595x500x80
EOAS	Activated charcoal filter for solvents (prefilter included)	510x405x60
EOBE	Activated charcoal filter for acids (prefilter included)	510x405x60
EOMP	Activated charcoal filter for solvents and acids (prefilter included)	510x405x60
EOPF	Prefilter	510x405x15

*To obtain the complete list of the connection accessories, see the chapter on ventilation of this catalogue and the current price list

CERTIFIED MULTI-RISK
COMBISTORAGE
CABINETS SERIES



Series COMBISTORAGE 60 FIRE TYPE 90

Certified according to EN14470-1 & EN14727



EOF239/2C



EOF239/3C

The maximum safety
for all your products.
Partitioned cabinet completely
fire-resistant TYPE90

→ TECHNICAL FEATURES:

- Completely made of an electrogalvanized steel plate with a thickness from 1 to 1.5 mm, cold bent - Grey RAL7035
- External finishing made of acidproof epoxy resin and passage through a thermal tunnel at 200 °C
- Cabinet isolation through some high density rock wool panels and some calcium sulphate panels
- Internal finishing with melamine panels highly resistant to chemical and aggressive vapours
- Structure allowing replacing spare parts if necessary
- Automatic door closing when the ambient temperature exceeds 50 °C
- 30 mm thermo-expanding isolation seals that in case of temperature rise ensure a perfect cabinet sealing, according to standard EN14470-1
- Air inlet and outlet with certified fire dampers closing ducts when the temperature exceeds 70°C according to standard DIN 4102-6
- Prearrangement for ventilation through a Ø 100mm flange for an external connection or a filtering ventilation system (see the chapter on ventilation)
- **Door closing and locking system allowing keeping the doors open** and closing them automatically if the ambient temperature is higher than 50 °C
- Spark resistant hinge ensuring a perfect door solidity
- Cabinet equipped with earthing

- Leveling jacks
- Door key lock
- Shelf made of painted steel or stainless steel whose height can be adjusted
- Shelf fastening on some aluminium eyelets excluding any spark risk
- Shelves tested to fire
- ISO 3864: Pictogram signalling
- Cabinets certified according to standards **EN14470-1** and **EN14727**

INTERNAL COMPARTMENTS to store various families of chemicals:

separation by means of panels made of HPL with a thickness of 18 mm coated with thermo-expanding seals (possibility of having up to 3 compartments and of customizing compartments - please contact us):

Compartment for «Inflammables»

- 1 retention shelf whose height can be adjusted and 1 retention tray with grid made of epoxy painted steel

Compartment for « Acids»

- 2 or 3 retention shelves whose height can be adjusted made of epoxy painted steel

Compartment for «Bases»

- 1 retention shelf whose height can be adjusted made of stainless steel

→ SERIES COMBISTORAGE FIRE 60 TYPE 90

CODE	DESCRIPTION	EXTERNAL DIMENSIONS (WxDxH) m	INTERNAL DIMENSIONS (WxDxH) mm	INTERNAL EQUIPMENT	STORAGE CAPACITY*	Weight kg
EOF239/2C**	Cabinet series COMBISTORAGE T90 with 1 door - 2 compartments	595x600x1950	496x446x680+842	COMPARTMENT FOR INFLAMMABLES: 1 shelf made of painted steel + 1 retention tray with grid COMPARTMENT FOR ACIDS/BASES: 3 shelves made of painted steel (max load 60 KG evenly distributed)	150	230
EOF232/3C**	Cabinet series COMBISTORAGE T90 with 2 doors - 3 compartments	1200x600x1950	540+540x680 +330+494	COMPARTMENT FOR INFLAMMABLES: 1 shelf made of painted steel + 1 retention tray with grid COMPARTMENT FOR ACIDS: 2 shelves made of painted steel COMPARTMENT FOR BASES: 1 shelf made of stainless steel (max load 60 KG evenly distributed)	150	232

*Approximate capacity in bottles holding 1 litre per cabinet

** Left door opening. Add « D » to the item code for the right door opening

→ INTERNAL EQUIPMENT (optional)

CODE	DESCRIPTION	DIMENSIONS (WxDxH) mm	RETENTION VOLUME (LITRES)	STORAGE CAPACITY*
RIP60VMY11	Additional shelf made of painted steel for inflammable compartment	493x420x39	7	30
RIP60XMY11	Additional shelf made of stainless steel for inflammable compartment	493x420x39	7	30
EOF85P	Additional shelf made of stainless steel for basis compartment	493x420x39	7	30
EOF45P	Additional shelf made of epoxy painted steel for acid & toxic compartment	493x420x39	7	30
PS50SMY11	Replacement system with closing thermal fuse - left door	-	-	-
PS50MY11	Replacement system with closing thermal fuse - right door	-	-	-
ZOCPAL60	Base plate for pallet truck W60	1200x600x110	-	-
CHEMIROLL	Wheel board to move the cabinets (the code ZOCPAL is necessary)	-	-	-
AT100	Visual and audible system with telephone transmission equipped with a digital thermostat with a T probe (°C) inside the cabinet			
TIM24	Daily counter	-	-	-
K89033	Internal carbon dioxide fire-extinguisher with automatic thermal tripping (62 °C)	Ø 90x280	-	-
AT100	Visual and audible system with telephone transmission equipped with a digital thermostat with a T probe (°C) inside the cabinet			
TIM24	Daily counter	-	-	-
K89033	Internal carbon dioxide fire-extinguisher with automatic thermal tripping (62 °C)	Ø 90x280	-	-

*Approximate capacity in bottles holding 1 litre

→ VENTILATION (en option)

CODE	DESCRIPTION	DIMENSIONS (WxDxH) mm
DIAM125BP	Air fresh box with power cable and filter box - outlet diameter 100 mm	290x290x270
EOF100ABPMY11	Air fresh box ATEX with power cable and filter box - outlet diameter 100 mm	270x260x430
K89007	Activated charcoal filter (to replace at least twice a year)	235x110x15
GFKIT100	External connection kit (1 metre of hose diam 100 mm and 2 clamps)	Ø 100 - W 1000 mm
CFN	Air fresh box with molecular filtration according to standard NFX15-211, with visual and audible alarm	550x500x220
CFNLH	Molecular filtration box manufactured according to standard NFX15-211	550x500x220
ADCFNMY11	Adapter for CFN box	595x500x80
EOAS	Activated charcoal filter for solvents (prefilter included)	510x405x60
EOBE	Activated charcoal filter for acids (prefilter included)	510x405x60
EOMP	Activated charcoal filter for solvents and acids (prefilter included)	510x405x60
EOPF	Prefilter	510x405x15

*To obtain the complete list of the connection accessories, see the chapter on ventilation of this catalogue and the current price list

Series ECO Plain doors

Certified according to EN61010-1



EO106P



EO104P/4C



EO103P/GS
with additional shelves
RIPCS60+RIP60SC



EO103P/D



EO104P/2C



EO104P/3C

The certified solution
for storing all your
families of chemicals

→ TECHNICAL FEATURES:

- Completely made of an electrogalvanized steel plate with a thickness of 10/10 mm, cold bent - Grey RAL7035
- External finishing made of acidproof epoxy resin and passage through a thermal tunnel at 200 °C
- Construction in one piece with jacks to level the cabinet
- Plain swing doors or with **double wall**
- Key lock
- Door opening with an angle of 110° allowing extracting shelves without tilting them
- Equipped with 3 fixed retention shelves made of painted steel, whose height can be adjusted
- Possibility of having some **sliding shelves** with W600 mm
- Possibility of having a retention tray on the cabinet bottom (see the table below)
- Ø 125mm connection collar
- Standardized pictograms according to standards ISO 3864
- **Complying with standards EN 61010-1 & CEI66-5**
- Complying with articles 5162 and 5170 of the Public Health Code

STORAGE CABINETS FOR CHEMICALS AND CORROSIVE SUBSTANCES

→ SERIES ECO

CODE	DESCRIPTION	EXTERNAL DIMENSIONS (WxDxH) mm	INTERNAL DIMENSIONS (WxDxH) mm	EQUIPEMENTS INTERNES	STORAGE CAPACITY**	Weight kg
FIXED SHELVES						
EO103P/G	Cabinet ECO6G 1 door with left opening	600x600x1950	595x567x1864	3 shelves made of painted steel (max load 60 KG evenly distributed)	100	78
EO103P/D	Cabinet ECO6D 1 door with right opening	600x600x1950	595x567x1864	3 shelves made of painted steel (max load 60 KG evenly distributed)	100	78
EO106P	Cabinet ECO12 2 doors - 1 compartment	1140x600x1950	1025x567x1864	3 shelves made of painted steel (max load 80 KG evenly distributed)	200	115
EO106P/2C	Cabinet ECO12 2 doors - 2 compartments	1140x600x1950	503+503x567 x1864	3 shelves made of painted steel per compartment (max load 60 KG evenly distributed)	200	125
EO104P/2C	Cabinet COMBICHEM 2C - 2 doors 2 superimposed compartments	600x600x1950	595x567x930 +930	2 shelves made of painted steel per compartment (max load 60 KG evenly distributed)	140	110
EO104P/3C	Cabinet COMBICHEM 3C - 3 doors 3 superimposed compartments	600x600x1950	595x567x618 +618+618	2 shelves made of painted steel per compartment (max load 60 KG evenly distributed)	210	115
EO104P/4C	Cabinet COMBICHEM 4C 4 doors - 4 compartments (2+2)	1140x600x1950	568+568x567x930 +930	2 shelves made of painted steel per compartment (max load 60 KG evenly distributed)	280	140
SLIDING SHELVES						
EO103P/GS	Cabinet ECO6G - Cabinet with 1 plain door and left opening	600x600x1950	595x567x1864	3 shelves made of painted steel (max load 60 KG evenly distributed)	100	80
EO103P/DS	Cabinet ECO6G - Cabinet with 1 door and right opening	600x600x1950	595x567x1864	3 shelves made of painted steel (max load 60 KG evenly distributed)	100	80
EO106PS	Cabinet ECO12 - Cabinet with 2 doors - 2 compartments	1140x600x1950	503+503x567 x1864	3 shelves made of painted steel per compartment (max load 60 KG evenly distributed)	200	130

*Approximate capacity in bottles holding 1 litre per cabinet

→ INTERNAL EQUIPMENT (optional)

CODE	DESCRIPTION	DIMENSIONS (WxDxH) mm	RETENTION VOLUME (LITRES)	STORAGE CAPACITY*
RIPCS60	Fixed shelf made of painted steel for cabinet with 1 door	485x545x34	9	35
RIPCS120	Fixed shelf made of painted steel for cabinet with 2 doors	1025x545x34	19	70
RIPX60	Fixed shelf made of stainless steel for cabinet with 1 door	485x545x34	9	35
RIPX120	Fixed shelf made of stainless steel for cabinet with 2 doors	1025x545x34	19	70
DIVECO120	Central division for cabinet ECO12 - with 2 doors	-	-	-
RIP60SC	«Sliding shelf»: Sliding system to be added to the shelf (only for cabinet with 1 door or cabinet with 2 compartments)	-	-	-
VACS60	Retention tray made of painted steel for cabinet with 2 doors	485x545x70	18	35
VACS120	Bac de rétention en acier peint pour armoire 2 portes	1025x545x70	39	70
VA60PP	Retention tray made of polypropylene for cabinet with 1 door	485x545x70	18	35
VA120PP	Retention tray made of polypropylene for cabinet with 2 doors	1025x545x70	39	70
COPCS60	Grid made of painted steel for cabinet with 1 door	485x545	-	35
COPCS120	Grid made of painted steel for cabinet with 2 doors	1025x545	-	70
TIM24	Daily counter	-	-	-
ALARME	Alarm system for «open doors»	-	-	-

*Approximate capacity in bottles holding 1 litre

→ VENTILATION (optional)

CODE	DESCRIPTION	DIMENSIONS (WxDxH) mm
K89190	Fresh air box with panelling for cabinet with 1 door - connecting Ø 125 mm	600x600x300
K89191	Fresh air box with panelling for cabinet with 2 door s - connecting Ø 125 mm	1140x600x300
DIAM125BP	Fresh air box with filter holding box for high cabinet with 1or 2 doors - outlet Ø: 125 mm (filter excluded)	290x290x270
K89007	Activated charcoal filter for motor DIAM125BP - (to replace at least twice a year)	235x110x15
K89021	Activated charcoal filter for motors K89190 and K89191 - (to replace at least twice a year)	300x240x15
RE1000	Fan flow controller (to be ordered with the fan K89013)	-
GFKIT125	Connection kit: 1 metre of flexible sheath Ø125 mm and 2 clamps	Ø125 mm
CFN	Fresh air box with molecular filtration according to standard NFX15-211, with visual and audible alarm	550x500x220
CFNLH	Molecular filtration box manufactured according to standard NFX15-211	550x500x220
EOAS	Activated charcoal filter for solvents (prefilter included)	510x405x60
EOBE	Activated charcoal filter for acids (prefilter included)	510x405x60
EOMP	Activated charcoal filter for solvents and acids (prefilter included)	510x405x60
EOPF	Prefilter	510x405x15

*To obtain the complete list of the connection accessories, see the chapter on ventilation of this catalogue and the current price list

Series ECO Glazed doors

Certified according to EN61010-1



EO106PG



EO104PG/4C



EO103PG/GS
with additional shelves
RIPCS60+RIP60SC



EO103PG/D



EO104PG/2C



EO104PG/3C

The certified solution
for storing your families
of chemicals

→ TECHNICAL FEATURES:

- Completely made of an electrogalvanized steel plate with a thickness of 10/10 mm, cold bent - Grey RAL7035
- External finishing made of acidproof epoxy resin and passage through a thermal tunnel at 200 °C
- Construction in one piece with leveling jacks
- Possibility of having 1, 2, 3 or 4 compartments for storing separately the different families of nonflammable chemical products
- Glazed swing doors with **double wall**
- Key lock

- Door opening with an angle of 110° allowing extracting the shelves without tilting them
- Equipped with fixed or sliding retention shelves made of painted steel, whose height can be adjusted
- Possibility of having a retention ray on the cabinet bottom (see the table below)
- Ø 125 mm connection collar
- Standardized pictograms according to standards ISO 3864
- **Complying with standards EN 61010-1 & CEI66-5**
- Complying with articles 5162 and 5170 of the Public Health Code

STORAGE CABINETS FOR CHEMICALS AND CORROSIVE SUBSTANCES

→ SERIES ECO

CODE	DESCRIPTION	EXTERNAL DIMENSIONS (WxDxH) mm	INTERNAL DIMENSIONS (WxDxH) mm	INTERNAL EQUIPMENT	STORAGE CAPACITY*	Weight kg
FIXED SHELVES						
EO103PG/G	Cabinet ECO6G Cabinet with 1 door and left opening	600x600x1950	595x567x1864	3 shelves made of painted steel (max load 60 KG evenly distributed)	100	78
EO103PG/D	Cabinet ECO6D Cabinet with 1 door and right opening	600x600x1950	595x567x1864	3 shelves made of painted steel (max load 60 KG evenly distributed)	100	78
EO106PG	Cabinet ECO12 Cabinet with 2 doors - 1 compartment	1140x600x1950	1025x567x1864	3 shelves made of painted steel (max load 80 KG evenly distributed)	200	115
EO106PG/2C	Cabinet ECO12 Cabinet with 2 doors 2 compartments	1140x600x1950	503+503x567 x1864	3 shelves made of painted steel per compartment (max load 60 KG evenly distributed)	200	125
EO104PG/2C	Cabinet COMBICHEM 2C Cabinet with 2 doors 2 superimposed compartments	600x600x1950	595x567x930 +930	2 shelves made of painted steel per compartment (max load 60 KG evenly distributed)	140	110
EO104PG/3C	Cabinet COMBICHEM 3C Cabinet with 3 doors 3 superimposed compartments	600x600x1950	595x567x618 +618+618	2 shelves made of painted steel per compartment (max load 60 KG evenly distributed)	210	115
EO104PG/4C	Cabinet COMBICHEM 4C - Cabinet with 4 doors - 4 compartments (2+2)	1140x600x1950	568+568x567x930 +930	2 shelves made of painted steel per compartment (max load 60 KG evenly distributed)	280	140
SLIDING SHELVES						
EO103PG/GS	Cabinet ECO6G - Cabinet with 1 plain door and left opening	600x600x1950	595x567x1864	3 shelves made of painted steel (max load 60 KG evenly distributed)	100	80
EO103PG/DS	Cabinet ECO6D Cabinet with 1 door with right opening	600x600x1950	595x567x1864	3 shelves made of painted steel (max load 60 KG evenly distributed)	100	80
EO106PGS	Cabinet ECO12 Cabinet with 2 doors - 2 compartments	1140x600x1950	503+503x567 x1864	3 shelves made of painted steel per compartment (max load 60 KG evenly distributed)	200	130

*Approximate capacity in bottles holding 1 litre per cabinet

→ INTERNAL EQUIPMENT (optional)

CODE	DESCRIPTION	DIMENSIONS (WxDxH) mm	RETENTION VOLUME (LITRES)	STORAGE CAPACITY*
RIPCS60	Fixed shelf made of painted steel for cabinet with 1 door	485x545x34	9	35
RIPCS120	Fixed shelf made of painted steel for cabinet with 2 doors	1025x545x34	19	70
RIPX60	Fixed shelf made of stainless steel for cabinet with 1 door	485x545x34	9	35
RIPX120	Fixed shelf made of stainless steel for cabinet with 2 doors	1025x545x34	19	70
DIVECO120	Central division for cabinet ECO12 - with 2 doors	-	-	-
RIP60SC	«Sliding shelf»: Sliding system to be added to the shelf (only for cabinet with 1 door or cabinet with 2 compartments)	-	-	-
VACS60	Retention tray made of painted steel for cabinet with 1 door	485x545x70	18	35
VACS120	Retention tray made of painted steel for cabinet with 2 doors	1025x545x70	39	70
VA60PP	Retention tray made of polypropylene for cabinet with 1 door	485x545x70	18	35
VA120PP	Retention tray made of polypropylene for cabinet with 2 doors	1025x545x70	39	70
COPCS60	Grid made of painted steel for cabinet with 1 door	485x545	-	35
COPCS120	Grid made of painted steel for cabinet with 2 doors	1025x545	-	70
TIM24	Daily counter	-	-	-
ALARME	Alarm system for «open doors»	-	-	-

*Approximate capacity in bottles holding 1 litre

→ VENTILATION (optional)

CODE	DESCRIPTION	DIMENSIONS (WxDxH) mm
K89190	Fresh air box with panelling for cabinet with 1 door - connecting Ø 125 mm	600x600x300
K89191	Fresh air box with panelling for cabinet with 2 doors - connecting Ø 125 mm	1140x600x300
DIAM125BP	Fresh air box with filter holding box for high cabinet with 2 doors - outlet Ø 125 mm (filter excluded)	290x290x270
K89007	Activated charcoal filter for motor DIAM125BP - (to replace at least twice a year)	235x110x15
K89021	Activated charcoal filter for motors K89190 and K89191 - (to replace at least twice a year)	300x240x15
RE1000	Fan flow controller (to be ordered with the fan K89013)	-
GFKIT125	Connection kit: 1 metre of flexible sheath Ø 125 mm and 2 clamps	Ø 125 mm
CFN	Fresh air box with molecular filtration according to standard NFX15-211, with visual and audible alarm	550x500x220
CFNLH	Molecular filtration box manufactured according to standard NFX15-211	550x500x220
EOAS	Activated charcoal filter for solvents (prefilter included)	510x405x60
EOBE	Activated charcoal filter for acids (prefilter included)	510x405x60
EOMP	Activated charcoal filter for solvents and acids (prefilter included)	510x405x60
EOPF	Prefilter	510x405x15

*To obtain the complete list of the connection accessories, see the chapter on ventilation of this catalogue and the current price list

Series ECO Multi-risk Plain doors



EO106PG



EOB124



EOB60UB



EOB120UB



EOB60



EOB62



EOB63

Modular solutions
to store your chemicals



External hinge made of plastic
resistant to corrosion

STORAGE CABINETS FOR CHEMICALS AND CORROSIVE SUBSTANCES

→ TECHNICAL FEATURES:

- Completely made of an electrogalvanized steel plate with a thickness of 15/10 mm, cold bent
- External finishing made of acidproof epoxy resin 90 microns Grey RAL7035 and passage through a thermal tunnel at 200 °C
- Construction in one piece with leveling jacks
- Division in 2, 3 or 4 compartments for storing separately the different families of nonflammable chemical products
- Plain swing doors with a single wall
- Key lock
- Door opening with an angle of 110° allowing extracting the shelves without tilting them
- External hinge made of plastic resistant to corrosion
- Compartments equipped with **fixed** retention shelves made of **painted** and stainless steel whose height can be adjusted
- Ø 125 mm connection collar
- Standardized pictograms according to standards ISO 3864

→ SERIES ECO

CODE	DESCRIPTION	EXTERNAL DIMENSIONS (WxDxH) mm	INTERNAL DIMENSIONS (WxDxH) mm	INTERNAL EQUIPMENT	STORAGE CAPACITY*	Weight kg
EOB60	Cabinet with 1 door 1 compartment	600x600x1950	595x567x1864	3 shelves made of painted steel (max load 60 Kg evenly distributed)	105	68
EOB62	Cabinet with 2 doors 2 superimposed compartments	600x600x1950	595x567x930 +930	Compartment for ACIDS: 2 shelves made of painted steel. Compartment for BASES: 2 fixed shelves made of stainless steel (max load 60 KG evenly distributed)	140	70
EOB63	Cabinet with 3 doors 3 superimposed compartments	600x600x1950	595x567x618 +618+618	Compartment for ACIDS: 2 shelves made of painted steel. Compartment for BASES: 2 shelves made of stainless steel. Compartment for TOXICS: 2 shelves made of painted steel (max load 60 KG evenly distributed)	210	73
EOB120	Cabinets with 2 doors 1 compartment	1140x600x1950	1025x567x1864	3 shelves made of painted steel (max load 80 KG evenly distributed)	210	125
EOB124	Cabinets with 4 doors 4 compartments (2+2)	1140x600x1950	568x568x567 x930+930	Compartment for ACIDS: 2 shelves made of painted steel. Compartment for BASES: 2 shelves made of stainless steel. Compartment for TOXICS: 2 shelves made of painted steel. Compartment for HARMFUL PRODUCTS: 2 shelves made of painted steel (max load 60 KG evenly distributed)	280	135
EOB60UB	Underbench cabinet with 1 door - 1 compartment	600x600x700	595x567x620	2 shelves made of painted steel (max load 60 Kg evenly distributed)	70	35
EOB120UB	Cabinet with 2 doors 1 compartment	1140x600x700	1025x567x620	2 shelves made of painted steel (max load 80 Kg evenly distributed)	140	50

*Approximate capacity in bottles holding 1 litre per cabinet

→ INTERNAL EQUIPMENT (optional)

CODE	DESCRIPTION	DIMENSIONS (WxDxH) mm	RETENTION VOLUME (LITRES)	STORAGE CAPACITY*
EOB60ETV	Fixed shelf made of painted steel for cabinet with 1 door	590x500x30	9	35
EOB60ETX	Fixed shelf made of stainless steel for cabinet with 1 door	590x500x30	9	35
EOB120ETV	Fixed shelf made of painted steel for cabinet with 2 doors	1130x500x30	17	70
EOB120ETX	Fixed shelf made of stainless steel for cabinet with 2 doors	1130x500x30	17	70
TIM24	Daily counter	-	-	-
ALARME	Alarm system for «open doors»	-	-	-

*Approximate capacity in bottles holding 1 litre

→ VENTILATION (en option)

CODE	DESCRIPTION	DIMENSIONS (WxDxH) mm
DIAM125BP	Fresh air box with filter holding box for high cabinet with 1or 2 doors - outlet Ø 125 mm (filter excluded)	290x290x270
K89007	Activated charcoal filter for motor DIAM125BP - (to replace at least twice a year)	235x110x15
F125	Ø 125 mm connection collar for underbench cabinets	Ø125 mm
RE1000	Fan flow controller (to be ordered with the fan K89013)	-
GFKIT125	Connection kit: 1 metre of flexible sheath Ø 125 mm and 2 clamps	Ø 125 mm
CFN	Fresh air box with molecular filtration according to standard NFX15-211, with visual and audible alarm	550x500x220
CFNLH	Molecular filtration box manufactured according to standard NFX15-211	550x500x220
CFNUB	Filtration box certified according to standard NFX15-211 for underbench cabinets, equipped with wheels, 2 ventilation outlets, with visual and audible alarm	400x500x650
CFNUBLH	Filtration box certified according to standard NFX15-211 for underbench cabinets, equipped with wheels, 2 ventilation outlets	400x500x650
EOAS	Activated charcoal filter (prefilter included)	510x405x60
EOBE	Activated charcoal filter for acids (prefilter included)	510x405x60
EOMP	Activated charcoal filter for solvents and acids (prefilter included)	510x405x60
EOPF	Prefilter	510x405x15

*To obtain the complete list of the connection accessories, see the chapter on ventilation of this catalogue and the current price list

Series ECO Multi-risk Glazed doors



EBO120V



EBO124V



External hinge made of plastic
resistant to corrosion

Modular solutions to store
your chemicals



EBO60V



EBO62V



EBO63V

→ TECHNICAL FEATURES:

- Completely made of an electrogalvanized steel plate with a thickness of 15/10 mm, cold bent
- External finishing made of acidproof epoxy resin 90 microns Grey RAL7035 and passage through a thermal tunnel at 200 °C
- Construction in one piece with leveling jacks
- Division in 2, 3 or 4 compartments for storing separately the different families of noninflammable chemical products
- Swing doors with single wall and polycarbonate glass, highly resistant to chemical attacks
- Key lock
- Door opening with an angle of 110° allowing extracting the shelves without tilting them
- External hinge made of plastic resistant to corrosion
- Compartments equipped with **fixed** retention shelves made of **painted** and **stainless** steel whose height can be adjusted
- Ø 125 mm connection collar
- Standardized pictograms according to standards ISO 3864

→ SERIES ECO

CODE	DESCRIPTION	EXTERNAL DIMENSIONS (WxDxH) mm	INTERNAL DIMENSIONS (WxDxH) mm	INTERNAL EQUIPMENT	STORAGE CAPACITY*	Weight (kg)
EOB60V	Cabinet with 1 glazed door 1 compartment	600x600x1950	595x567x1864	3 shelves made of painted steel (max load 60 Kg evenly distributed)	105	68
EOB62V	Cabinet 2 glazed doors 2 superimposed compartments	600x600x1950	595x567x930+930	Compartment for ACIDS: 2 shelves made of painted steel. Compartment for BASES: 2 fixed shelves made of stainless steel (max load 60 KG evenly distributed)	140	70
EOB63V	Cabinet 3 glazed doors 3 superimposed compartments	600x600x1950	595x567x618 +618+618	Compartment for ACIDS: 2 shelves made of painted steel. Compartment for BASES: 2 shelves made of stainless steel. Compartment TOXICS: 2 shelves made of painted steel (max load 60 KG evenly distributed)	210	73
EOB120V	Cabinet with 2 glazed doors 1 compartment	1140x600x1950	1025x567x1864	3 shelves made of painted steel (max load 80 K evenly distributed)	210	125
EOB124V	Cabinet with 4 glazed doors 4 compartments (2+2)	1140x600x1950	568+568x567 x930+930	Compartment for ACIDS: 2 shelves made of painted steel. Compartment for BASES: 2 shelves made of stainless steel. Compartment TOXICS: 2 shelves made of painted steel. Compartment for HARMFUL PRODUCTS: 2 shelves made of painted steel (max load 60 KG evenly distributed)	280	135

*Approximate capacity in bottles holding 1 litre per cabinet

→ INTERNAL EQUIPMENT (optional)

CODE	DESCRIPTION	DIMENSIONS (WxDxH) mm	RETENTION VOLUME (LITRES)	STORAGE CAPACITY*
EOB60ETV	Fixed shelf made of painted steel for cabinet with 1 door	590x500x30	9	35
EOB60ETX	Fixed shelf made of stainless steel for cabinet with 1 door	590x500x30	9	35
EOB120ETV	Fixed shelf made of painted steel for cabinet with 2 doors	1130x500x30	17	70
EOB120ETX	Fixed shelf made of stainless steel for cabinet with 2 doors	1130x500x30	17	70
TIM24	Daily counter	-	-	-
ALARME	Alarm system for «open doors»	-	-	-

*Approximate capacity in bottles holding 1 litre

→ VENTILATION (optional)

CODE	DESCRIPTION	DIMENSIONS (WxDxH) mm
DIAM125BP	Fresh air box with filter holding box for high cabinet with 1or 2 doors - outlet Ø125 mm (filter excluded)	290x290x270
K89007	Activated charcoal filter for motor DIAM125BP - (to replace at least twice a year)	235x110x15
RE1000	Fan flow controller (to be ordered with the fan K89013)	-
GFKIT125	Connection kit: 1 metre of flexible sheath Ø 125 mm and 2 clamps	Ø 125 mm
CFN	Fresh air box with molecular filtration according to standard NFX15-211, with visual and audible alarm	550x500x220
CFNLH	Molecular filtration box manufactured according to standard NFX15-211	550x500x220
EOAS	Activated charcoal filter for solvents (prefilter included)	510x405x60
EOBE	Activated charcoal filter for acids (prefilter included)	510x405x60
EOMP	Activated charcoal filter for solvents and acids (prefilter included)	510x405x60
EOPF	Prefilter	510x405x15
EOBE	Activated charcoal filter for acids (prefilter included)	510x405x60
EOMP	Activated charcoal filter for solvents and acids (prefilter included)	510x405x60
EOPF	Prefilter	510x405x15

*To obtain the complete list of the connection accessories, see the chapter on ventilation of this catalogue and the current price list



Series ECOW

Certified according to EN61010-1



✓
Panels made of HPL resistant to corrosion



K89020



K89019



Door cushioning system



Sliding shelves made of PP (underbench cabinet)



K89180



K89179



K89180

→ TECHNICAL FEATURES:

- Cabinet body made of waterproof agglomerate coated with plastic melamine HPL fireproof F1 with rounded edges Grey RAL7035
- Removable construction with leveling jacks on a metal base plate
- Metal parts (hinges, clips, guides) painted against corrosion
- Door opening with an angle higher than 110°
- Key lock
- Two separate compartments (on cabinets with two doors)
- High cabinets equipped with 2 fixed retention shelves made of polypropylene per compartment, whose height can be adjusted
- Underbench cabinets equipped with two removable drawers with retention tray made of polypropylene (fixed with velcro), per compartment
- Underbench cabinets placed on a metal base plate with a height of 60 mm
- Max load per shelf: 60 Kg evenly distributed
- Cushioning system of doors and drawers
- Ø 125 mm connection collar
- Standardized pictograms according to standards ISO 3864
- **Complying with standards EN 61010-1 & CEI 66-5**

→ SERIES ECOW

CODE	DESCRIPTION	EXTERNAL DIMENSIONS (WxDxH) mm	INTERNAL DIMENSIONS (WxDxH) mm	INTERNAL EQUIPMENT	STORAGE CAPACITY*	Weight (kg)
K89020	Cabinet ECO6W Cabinet with 1 door	630x600x1950	1150x580x1890	2 shelves made of PP (charge max 60 Kg evenly distributed)	40	85
K89019	Cabinet ECO12W Cabinet with 2 doors 2 compartments	1190x600x1950	1150x580x1890	2 shelves made of PP per compartment (max load 60 Kg evenly distributed)	80	120
K89180	Cabinet ECO6BW Underbench Cabinet with 1 door	560x500x640 +60 (socle)	1150x480x580	2 removable drawers with retention tray made of PP (max load 60 Kg evenly distributed)	40	39
K89179	Cabinet ECO12W Underbench cabinet with 2 doors - 2 compartments	1120x500x640 +60 (socle)	1150x480x580	2 removable drawers with retention tray made of PP per compartment (max load 60 Kg evenly distributed)	80	83

*Approximate capacity in bottles holding 1 litre per cabinet

→ INTERNAL EQUIPMENT (optional)

CODE	DESCRIPTION	DIMENSIONS (WxDxH) mm	RETENTION VOLUME (LITRES)	STORAGE CAPACITY*
WLRIP6060	Fixed shelf made of PP for high cabinet with 1 or 2 doors	550x530x50	12	20
RIPWPP	Additional shelf made of PP for cabinet ECO6BW and ECO12BW	480x380x40	7	15
TIM24	Daily counter	-	-	-

*Approximate capacity in bottles holding 1 litre

→ VENTILATION (optional)

CODE	DESCRIPTION	DIMENSIONS (WxDxH) mm
DIAM125BP	Fresh air box with filter holding box for high cabinet with 1or 2 doors - outlet Ø125 mm (filter excluded)	290x290x270
K89007	Activated charcoal filter for motor DIAM125BP - (to replace at least twice a year)	235x110x15
RE1000	Fan flow controller (to be ordered with the fan K89013)	-
GFKIT125	Connection kit: 1 metre of flexible sheath Ø 125 mm and 2 clamps	Ø 125 mm
CFN	Fresh air box with molecular filtration according to standard NFX15-211	550x500x220
CFNLH	Molecular filtration box manufactured according to standard NFX15-211, without alarm	550x500x220
CFNUB	Fresh air box certified according to standard NFX15-211 for underbench cabinets, equipped with wheels, 2 ventilation outlets	400x500x650
CFNUBLH	Fresh air box certified according to standard NFX15-211 for underbench cabinets, equipped with wheels, 2 ventilation outlets without alarm	400x500x650
EOAS	Activated charcoal filter for solvents (prefilter included)	510x405x60
EOBE	Activated charcoal filter for acids (prefilter included)	510x405x60
EOMP	Activated charcoal filter for solvents and acids (prefilter included)	510x405x60
EOPF	Prefilter	510x405x15

* To obtain the complete list of the connection accessories, see the chapter on ventilation of this catalogue and the current price list

Series High density PVC

Plain doors

Certified according to EN 61010-1



EO102PVC



EO103PVC



EO104BPVC



EO104PVC



EO105PVC



EO106PVC



EO101PVC



EO100PVC

It is ideal for storing very aggressive chemicals

→ TECHNICAL FEATURES:

- Completely manufactured from 18 mm thickness of PVC HD
- Cover fan and plinth completely manufactured from 1,0 mm thickness steel sheet, cold pressed, epoxy coated with acid resistant epoxy powders electro-statically applied at a temperature of 200 °C, which ensures a layer thickness higher than 90 microns on the whole surface of the cabinet
- One- piece structure built on a 15/10 mm plinth with leveling jacks
- Division in 2, 3 or 4 compartments for storing separately the different families of not flammable chemical products
- Single- wall hinged plain doors
- Key lock
- Door opening with an angle of 110° allowing extracting the shelves without tilting them
- External hinge made of plastic resistant to corrosion
- Compartments equipped with retention shelves made in PVC whose height can be adjusted
- Ø 125 mm connection collar
- Available with or without ventilation unit
- Modular solutions
- Basin form shelf
- In compliance with EN 61010 Norm
- Standardized pictograms according to standards ISO 3864

→ SERIES ECO PVC

CODE	DESCRIPTION	EXTERNAL DIMENSIONS (WxDxH) mm	INTERNAL DIMENSIONS (WxDxH) mm	INTERNAL EQUIPMENT	STORAGE CAPACITY*	Weight (kg)
EO102PVC	Cabinet with 1 door - 1 compartment	600x600x1600	562x562x1470	3 PVC shelves (max load 40 KG evenly distributed)	75	77
EO103PVC	Cabinet with 1 door - 1 compartment Fan and filter included	600x600x1900	562x562x1470	3 PVC shelves (max load 40 KG evenly distributed)	75	85
EO104BPVC	Cabinet with 2 doors 2 compartments stacked one on top of the other	600x600x1600	562x562x1470	2 PVC shelves per compartment (max load 40 KG evenly distributed)	100	78
EO104PVC	Cabinet with 2 doors 2 compartments stacked one on top of the other Fan and filter included	600x600x1900	562x562x1470	2 PVC shelves per compartment (max load 40 KG evenly distributed)	100	86
EO105PVC	Cabinet with 2 doors 2 compartments (vertical partition wall)	1140x600x1600	1102x562x1470	3 PVC shelves per compartment (max load 40 KG evenly distributed)	150	87
EO106PVC	Cabinet with 2 doors 2 compartments (vertical partition wall) Fan and filter included	1140x600x1900	1102x562x1470	3 PVC shelves per compartment (max load 40 KG evenly distributed)	150	99
EO101PVC	Underbench cabinet with 1 door	600x500x790	562x462x752	2 PVC shelves per compartment (max load 40 KG evenly distributed)	50	32
EO100PVC	Underbench cabinet with 2 doors 2 compartments	1140x500x790	1102x462x752	2 PVC shelves per compartment (max load 40 KG evenly distributed)	100	43

*Approximate capacity in bottles holding 1 litre per cabinet

→ INTERNAL EQUIPMENT (optional)

CODE	DESCRIPTION	DIMENSIONS (WxDxH) mm	RETENTION VOLUME (LITRES)	STORAGE CAPACITY*
WLRIP6060	Additional shelf in PVC	545x535x30	9	25
TIM24	Daily counter	-	-	-
ALARME	Alarm system for «open doors»	-	-	-

*Approximate capacity in bottles holding 1 litre

→ VENTILATION (optional)

CODE	DESCRIPTION	DIMENSIONS (WxDxH) mm
DIAM125BP	Fresh air box with filter holding box for high cabinet with 1 or 2 doors- outlet Ø 125 mm (filter excluded)	290x290x270
K89007	Activated charcoal filter for motor DIAM125BP - (to replace at least twice a year)	235x110x15
F125C	Duct connector Ø 125 mm for underbench cabinets	Ø 125 mm
RE1000	Fan flow controller (to be ordered with the fan K89013)	-
GFKIT125	Connection kit: 1 metre of flexible sheath Ø 125 mm and 2 clamps	Ø 125 mm
RFC560	Spare filter for 600 mm exhausted cabinet	
RFC5120	Spare filter for 1140 mm exhausted cabinet	
RSOLCA	Filter Acids for exhaust fan DIAM125BP	

*To obtain the complete list of the connection accessories, see the chapter on ventilation of this catalogue and the current price list

BOX FOR POISON STORAGE

Specially conceived for storing and isolating poisons, toxic chemical products and CMR.



EO106P+K89048



K89048

It can be used
as wall cabinet to store
your harmful products
or as poison box
in a storage cabinet

→ TECHNICAL FEATURES:

- Made of steel 10/10th
- Colour: Grey RAL7035
- Equipped with 2 retention shelves made of epoxy painted steel, whose height can be adjusted
- Swing door with **double wall** and key lock
- Door opening with an angle higher than 110°
- Prearrangement for wall mountin
- Possibility of fastening in a safety cabinet (on the shelf or on the cabinet bottom wall)
- Standardized pictograms according to standards ISO 3864

→ POISON BOX

CODE	DESCRIPTION	EXTERNAL DIMENSIONS (WxDxH) mm	INTERNAL DIMENSIONS (WxDxH) mm	INTERNAL EQUIPMENT	STORAGE CAPACITY*	Weight (kg)
K89048	Poison box	500x300x400	480x270x390	2 shelves made of painted steel (max load Kg evenly distributed)	25	10

*Approximate capacity in bottles holding 1 litre per cabinet

Series E-LINE

Safety cabinets

The cabinets of series E-UNE represent the ideal solution for a cheap and safe storage of all your polluting, toxic and dangerous products.

Practical and cheap
Ideal for storing
your products

According to article **R.5132-66 of the Public Health Code**, toxic and very toxic products must be placed in key locked cabinets. Article **R.5132.68** also establishes that the dangerous substances or preparations must be kept separate from other substances or preparations.

Moreover, the **Public Health Code** obliges employers to ensure health and safety of their workers (**art. L230-2**).



→ TECHNICAL FEATURES:

- Made of steel 8/10th
- Colour: Grey RAL7035
- Equipped with retention shelves made of epoxy painted steel, whose height can be adjusted
- Plain swing doors with **single wall** and 3 point key lock
- Door opening with an angle higher than 110°
- Ø 125 mm connection collar
- Standardized pictograms according to standards ISO 3864

→ SERIES E-LINE

CODE	DESCRIPTION	EXTERNAL DIMENSIONS (WxDxH) mm	INTERNAL DIMENSIONS (WxDxH) mm	INTERNAL EQUIPMENT	STORAGE CAPACITY*	Weight (kg)
K89173	High cabinet with 1 door	540x450x2000	530x430x1980	3 shelves + 1 retention tray made of painted steel (max load 60 Kg evenly distributed)	64	45
K89172	High cabinet with 2 doors	1000x450x2000	990x430x1980	3 shelves + 1 retention tray made of painted steel (max load 80 Kg evenly distributed)	100	65
K89176	Cabinet counter with 1 door	540x450x1000	530x430x998	1 shelf + 1 retention tray made of painted steel (max load 60 Kg evenly distributed)	30	35
K89175	Cabinet counter with 2 doors	1000x450x1000	990x430x998	1 shelf + 1 retention tray made of painted steel (max load 80 Kg evenly distributed)	70	45

*Approximate capacity in bottles holding 1 litre per cabinet

→ INTERNAL EQUIPMENT (optional)

CODE	DESCRIPTION	DIMENSIONS (WxDxH) mm	RETENTION VOLUME (LITRES)	STORAGE CAPACITY*
K89192	Shelf made of painted steel for cabinet with 1 door	495x415x30	6	16
K89193	Shelf made of painted steel for cabinet with 2 doors	990x415x30	12	36

*Approximate capacity in bottles holding 1 litre

→ VENTILATION (optional)

CODE	DESCRIPTION	DIMENSIONS (WxDxH) mm
DIAM125BP	Fresh air box with filter holding box for high cabinet with 1or 2 doors inlet/outlet Ø 125 mm (filter excluded)	290x290x270
RE1000	Fan flow controller (to be ordered with the fan K89013)	-
K89021	Activated charcoal filter for fresh air box K89190-K89191-K89013	300x240x15
GFKIT125	Connection kit: 1 metre of flexible sheath Ø 125 mm and 2 clamps	Ø 125 mm
TIM24	Daily counter	-

*To obtain the complete list of the connection accessories, see the chapter on ventilation of this catalogue and the current price list



→ TECHNICAL FEATURES:

- Completely made of an electrogalvanized steel plate with a thickness of 10/10 mm, cold bent
- External finishing made of acidproof epoxy resin 90 microns Grey RAL7035 and passage through a thermal tunnel at 200 °C
- Construction in one piece with leveling jacks
- Plain swing or glazed doors with double wall
- Door opening with an angle of 110° allowing extracting the shelves without tilting them
- Key lock
- Equipped with 3 retention shelves made of STAINLESS steel, with a thickness of 10/10 mm, whose height can be adjusted
- Ventilation unit included **CE** with box made of painted steel and aluminium propeller
- Protection degree: IP44 according to UNEL-IEC
- Flow 300 m³/h
- Sound level lower than 6dB at the moment of the maximum flow with 1.5 m sheath according to UNI 7179-73P
- Mp. 0.09 Kw., 2900 revolutions.
- Complying with standard EN61010
- Supply: 220/230V 50Hz single phase
- Absorption: 90W
- Connection diameter: 100 mm
- Equipped with a particle filter HEPA H14 made of glass micro-fibre with MPPS 99,995%, flow 150 m³/h, structure made of anodized aluminium
- Equipped with an activated charcoal filter for acids with a big absorption surface
- Filter replacement made easier by the hinge system with key lock
- Standardized pictograms according to standards ISO 3864

→ SERIE CYTOTOXIQUE

CODE	DESCRIPTION	EXTERNAL DIMENSIONS (WxDxH) mm	INTERNAL DIMENSIONS (WxDxH) mm	INTERNAL EQUIPMENT	STORAGE CAPACITY*	Weight (kg)
EO103H	Armoire 1 porte pleine	600x600x1900 (1600+300)	550x550x1500	3 étagères en acier inox (490x550x30 mm)	100	93
EO106H	Armoire 2 portes pleines	1140x600x1900 (1600+300)	1080x550x1500	3 étagères en acier inox (1030x550x30 mm)	200	130
EO103GH	Armoire 1 porte vitrée	600x600x1900 (1600+300)	550x550x1500	3 étagères en acier inox (490x550x30 mm)	100	95
EO106GH	Armoire 2 portes vitrées	1140x600x1900 (1600+300)	1080x550x1500	3 étagères en acier inox (1030x550x30 mm)	200	133

*Approximate capacity in bottles holding 1 litre per cabinet

→ INTERNAL EQUIPMENT (optional)

CODE	DESCRIPTION	DIMENSIONS (WxDxH) mm	RETENTION VOLUME (LITRES)	STORAGE CAPACITY*
RIPWPP	Additional shelf made of PP for cabinet ECO6BW and ECO12BW	480x380x40	7	15
RIPWPP	Additional shelf made of PP for cabinet ECO6BW and ECO12BW	480x380x40	7	15
RIPWPP	Additional shelf made of PP for cabinet ECO6BW and ECO12BW	480x380x40	7	15
RIPWPP	Additional shelf made of PP for cabinet ECO6BW and ECO12BW	480x380x40	7	15
RIPWPP	Additional shelf made of PP for cabinet ECO6BW and ECO12BW	480x380x40	7	15

*Approximate capacity in bottles holding 1 litre

Standard NFX15-211

➔ WHAT THE STANDARD SAYS

This standard defines precisely the filtration system capacity of a fume hood to retain the harmful molecules evaporated in the enclosure and qualifies the air quality after the filter.

During the « normal operation» phase, standard AFNOR NF X 15 211 imposes a maximum concentration after the filtration system which must not exceed 1% of the TLV of the product handled.

Standard AFNOR NF X 15 211 deals with the performances of a fume hood as a whole: containment, speed, filtration system effectiveness. This standard does not define in any case the properties of a single and isolated filter of a filtration system. Therefore, a single filter cannot comply with standard AFNOR NFX 15 211.

Mandated by AFNOR, the Union de Normalisation Mécanique (UNM), made of a board of experts for ventilation, of government bodies, of professional trade union members, established standard AFNOR NFX 15-211:2009. This standard applies to fume hoods conceived for research and analysis works... for all laboratories handling chemical agents subject to a professional exposure limit value (TLV or OEL). This text imposes some performance criteria connected to:

- 1 - The filtration effectiveness
- 2 - The containment effectiveness
- 3 - The air effectiveness on the front
- 4 - The documentation accompanying the fume hoods

CLASS 1	CLASS 2
Fume hoods with safety reserve	Fume hoods without safety reserve
One main filtration level and one safety filtration level	Un niveau de filtration principal

The classes of standard AFNOR NF X 15-211: 2009

DENOMINATION ACCORDING TO NFX 15-211 :2009	
Particle filtration	Type P
Vapour filtration	Type V
Particle and vapour filtration	Type PV

	CLASS 1	CLASS 2
Normal operating phase	Normal operating phase during which the concentration after the filter must be lower than 1% of TLV	
Detection phase	Detection phase during which the concentration after the filters must be lower than 1% of TLV and during which the automatic detector of saturation must warn the user	Detection phase during which the concentration after the filters must be lower than 50% of TLV
Safety phase	Safety phase during which the concentration after the filters must be lower than 50% of TLV and whose duration must not be lower than 1/12 of the duration of the normal operating phase	

Special prescriptions for enclosures of class 1

The enclosures of class 1 must be conceived for handling products whose OEL is higher or equal to 1 ppm.

The enclosures of class 1 must include a continuous measuring system of concentration, after the filter, associated to an alarm.

1 - The filtration effectiveness

It indicates the filter capacity to retain the harmful molecules handled in the enclosure and qualifies the recirculated air quality after the filter.

2 - The containment effectiveness

It defines the fume hood capacity to retain the vapours or the particles in the enclosure without dispersing them into the laboratory atmosphere.

3 - The air effectiveness on the front

It indicates the fume hood capacity to create a dynamic barrier between the operator and what he handles.

For fume hoods with fixed front, the front air speed at any point along the opening must be between 0.4 and 0.6 m/s. Furthermore, they must be equipped with a continuous monitoring device of ventilation.

4 - The documentation accompanying the fume hoods

The fume hoods must be accompanied by a booklet including an exhaustive list of the chemical agents that according to the manufacturer's certification can be handled in the fume hood in compliance with the conditions described in standard NFX 15-211:2009

Special prescriptions for enclosures of class 2

The enclosures of class 2 must be conceived for handling products whose OEL is higher or equal to 10 ppm.

The enclosures of class 2 must include:

- Either an (audible or visual) alarm triggered by an hour meter every 60 working hours
- Or a continuous measuring system of the concentration after the filter connected to an alarm

The product mass that can be inserted into the enclosure must not exceed 1/8 of the retention capacity of the filter during normal operation.

➤ OPERATING PRINCIPLE OF A FUME HOOD

➔ OPERATION OF AN ACTIVATED CHARCOAL FUME HOOD

The harmful vapours are contained in the working volume, sucked by the ventilation unit and purified through their passage in the activated charcoal filter before being rejected into the atmosphere. You will find below the important parameters to consider for the good operation of the activated charcoal filter:

➔ CONCENTRATION

The higher the concentration of the handled products, the higher the quantity of coal that will be necessary.

➔ TEMPERATURE

The lower the temperature, the better the absorption capacity.

➔ PRESSURE

The higher the pressure, the better the absorption capacity.

➔ HUMIDITY

The lower the humidity, the better the absorption capacity.

➔ AIR FLOW SPEED

through the activated charcoal filter (0.2 m/s).

Alors que les 4 premiers paramètres sont généralement constants dans un laboratoire, la vitesse de l'air est donnée par le système d'aspiration.

While the first 4 parameters are generally constant in a laboratory, the air speed is given by the suction system. We conceived an electronic measuring system, allowing checking this fundamental parameter in order to optimize the absorption of chemical substances through the «coal bed». An anemometer sensor controls the speed of the air passage through the activated charcoal filter (about 0.2 m/s). It sends this information to the microprocessor validating the value if it is correct via a green light-emitting diode (LED) on the control panel. In case of a speed lower than 0.2 m/s, a red light-emitting diode LED flashes slowly.

If the speed is much higher than 0.2 m/s, the same red diode LED will flash more quickly. In these two cases, it will be possible to intervene manually to restore the good speed by means of the electronic regulator. In this way the inlet air flow speed on the front will be between 0.4 and 0.6 m/s.

These are the results obtained starting from the fume HOOD CHEMIHOOD PLUS:

➔ Results of the test with carbon tetrachloride (CCl₄)

OPERATION	NORMAL	DETECTION	SAFETY	OCCURRENCE
Average air temperature (°C)	21,0	20,3	20,5	19,8
Average relative humidity (%)	55	54	59	52
Sampling flow (L/min)	0,8	0,8	0,8	0,8
Sampling time (min)	480	480	480	480
Treated air volume (m ³)	0,382	0,381	0,383	0,384
Mass of CCl ₄ absorbed (g)	2542	113	175	165
Concentration of CCl ₄ rejected (ppm)	0	0	0	0
Volume discharged (ml)	/	/	/	180
% OEL	0	0	0	0
% TLV	0	0	0	0

➔ Results of the test with hydrochloric acid (HCl)

FONCTIONNEMENT	NORMAL	DETECTION	SECURITE	INCIDENT
Average air temperature (°C)	20,6	21,1	20,8	20,9
Average relative humidity (%)	54	53	54	52
Sampling flow (L/min)	0,8	0,8	0,8	0,8
Sampling time (min)	480	480	480	480
Treated air volume (m ³)	0,382	0,383	0,382	0,382
Mass of CCl ₄ absorbed (g)	1588	776	134	287
Concentration of CCl ₄ rejected (ppm)	0	0	0,04	3,93
Volume discharged (ml)	/	/	/	100
% OEL	/	/	/	/
% TLV	0	0	0,8	78,6

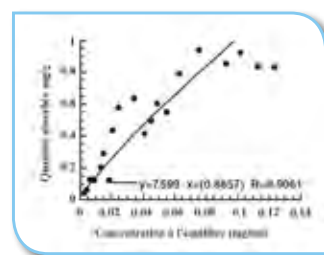
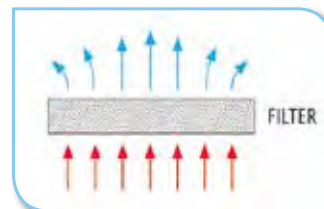

➤ OPERATING PRINCIPLE OF A FILTERING CABINET

The harmful vapours contained in the storage cabinet are sucked by the ventilation box and purified when they pass through the activated charcoal filter before being rejected into the atmosphere. The vapour filtration occurs in a specific manner by choosing a suitable activated charcoal filter.

All toxic vapours emitted by the storage of chemicals are eliminated by ensuring a purified air inside the laboratory.

This system, which is easier and cheaper to implement, allows the cabinet ventilation without any external connection and without air compensation problems in the room. The ventilated cabinet can be installed everywhere in your laboratory and near workstations.

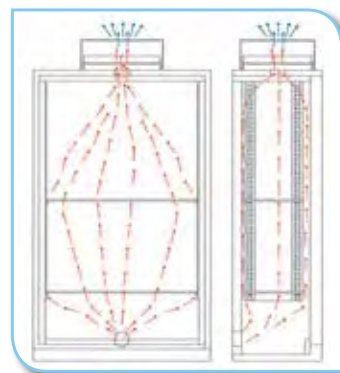

Series ECO F - Fixed shelves - Glass doors

Certified according to NFX15-211 & EN61010-1



CFE0-103GP



CFE0-104/2CV



CFE0-106GP

Safely removing noxious vapours
with no need of external connections

→ TECHNICAL FEATURE OF CABINETS:

- Completely made of electrogalvanized stainless steel with a thickness of 10/10 mm, cold bent - Grey RAL7035
- External finishing made of acidproof epoxy resin and passage through a thermal tunnel at 200 °C
- One-piece structure with levelling jacks
- **Swing door with double wall, provided with glass Sécurit 6 mm (3mm + polyvinyl film + 3mm)**
- Key lock
- Door opening with an angle of 110° allowing extracting the shelves without tilting them
- Equipped with 4 fixed shelves + 1 retention tray made of painted steel, whose height can be adjusted, **per compartment**
- Standardized pictograms according to standards ISO 3864
- **Complying with standards EN 601010-1 & CEI 66-5**
- Complying with articles 5162 and 5170 of the Public Health Code
- Equipped with a filtering fresh air box complying with the standard AFNOR NFX 15-211 **(filter should be chosen according to the stored products)**

→ TECHNICAL FEATURES OF THE FRESH AIR BOX WITH FILTRATION:

- Electrogalvanized steel structure 10/10 mm, covered in a grey epoxy paint RAL 7035
- Axial fan (turbine)
- Flow rate: 100/250 m³/h
- Voltage/frequency: 220 volts/50Hertz
- IP44
- Acoustic level 45dB
- Complying with the standard ISO 3744
- ON/OFF switch with light indicators for proper working
- LED visual and acoustic working hour meter
- Filter saturation indicator with LED visual and acoustic indicator: speed measurement of the air passing through the activated charcoal filter
- Retention capacity CCl₄ on a 7000g-filter (in compliance with the efficiency level defined by the **standard AFNOR NFX 15-211**) or maximum rejection of 50% of the average exposure value of the product
- Please see the ventilation chapter for the detailed sheet of the fresh air box with filtration in compliance with the standard NFX 15-211

→ SERIE ECO F

CODE	DESCRIPTION	EXTERNAL DIMENSIONS (WxDxH) mm	INTERNAL DIMENSIONS (WxDxH) mm	INTERNAL EQUIPMENT	STORAGE CAPACITY*	Weight (kg)
CFEO-103GP	Cabinet Series ECOF6 Cabinet with 1 glass door	600x600x1950	595x567x1864	4 shelves made of painted steel (max load 60 Kg evenly distributed) + 1 retention tray with grid made of painted steel and absorbent mat	170	95
CFEO-106GP	Cabinet Series ECOF12 Cabinet with 2 glass doors 2 compartments	1140x600x1950	503x503x567x1864	4 shelves made of painted steel (max load 60 Kg evenly distributed) + 1 retention tray with grid made of painted steel and absorbent mat per compartment	350	180
CFEO-104/2CV	Cabinet Series COMBICHEM F 2C Cabinet with 2 glass doors 2 superimposed compartments	600x600x1950	595x567x930+930	2 shelves made of painted steel (max load 60 Kg evenly distributed) + 1 retention tray with grid made of painted steel and absorbent mat per compartment	210	115

*Approximate capacity in bottles holding 1 litre per cabinet

→ INTERNAL EQUIPMENT (OPTIONAL)

CODE	DESCRIPTION	DIMENSIONS (WxDxH) mm	RETENTION VOLUME (LITRES)	STORAGE CAPACITY*
RIPCS60	Fixed shelf made of painted steel for cabinet with 1 door	485x545x34	9	35
RIPCS120	Fixed shelf made of painted steel for cabinet with 2 doors	1025x545x34	19	70
RIPX60	Fixed shelf made of stainless steel for cabinet with 1 door	485x545x34	9	35
RIPX120	Fixed shelf made of stainless steel for cabinet with 2 doors	1025x545x34	19	70
VACS60	Retention tray made of painted steel for cabinet with 1 door	485x545x70	18	35
COPCS60	Grid made of painted steel for cabinet with 1 door	485x545	-	35
CS-ABS	Absorbent paper - set of 4 sheets 50x40 cm	-	-	-
ALARME	Alarm system "open doors"	-	-	-

*Approximate capacity in bottles holding 1 litre

→ VENTILATION

CODE	DESCRIPTION	DIMENSIONS (WxDxH) mm
CFN	Fresh air box with molecular filtration according to standard NFX15-211, with visual and acoustic alarm - supplied along with the cabinet	550x500x220
EOAS	Activated charcoal filter for solvents (pre-filter included)	510x405x60
EOBE	Activated charcoal filter for acids (pre-filter included)	510x405x60
EOMP	Activated charcoal filter for solvents and acids (pre-filter included)	510x405x60
EOPF	Pre-filter	510x405x15

*To obtain the complete list of the connection accessories, see the chapter on ventilation of this catalogue and the current price list

Series ECO F - Sliding shelves - Glass doors

Certified according to NFX15-211 & EN61010-1



CF4TEO-103GP



CF8TEO-108GP

Easy access to bottles thanks to the sliding shelves



→ TECHNICAL FEATURE OF CABINETS:

- Completely made of electrogalvanized stainless steel with a thickness of 10/10 mm, cold bent - Grey RAL7035
- External finishing made of acidproof epoxy resin and passage through a thermal tunnel at 200 °C
- One-piece structure with levelling jacks
- **Swing door with double wall, provided with glass Sécurité 6 mm (3mm + polyvinyl film + 3 mm)**
- Key lock
- Door opening with an angle of 110° allowing extracting the shelves without tilting them
- Equipped with sliding shelves and retention tray with grid made of painted steel and absorbent mat
- Standardized pictograms according to standards ISO 3864
- **Complying with standards EN 601010-1 & CEI 66-5**
- Complying with articles 5162 and 5170 of the Public Health Code
- Equipped with a filtering fresh air box complying with the standard AFNOR NFX 15-211 **(filter should be chosen according to the stored products)**

→ TECHNICAL FEATURES OF THE FRESH AIR BOX WITH FILTRATION:

- Electrogalvanized steel structure 10/10 mm, covered in a grey epoxy paint RAL 7035
- Axial fan (turbine)
- Flow rate: 100/250 m³/h
- Voltage/frequency: 220 volts/50Hertz
- IP44
- Acoustic level 45dB
- Complying with the standard ISO 3744
- ON/OFF switch with light indicators for proper working
- LED visual and acoustic working hour meter
- Filter saturation indicator with LED visual and acoustic indicator: speed measurement of the air passing through the activated charcoal filter
- Retention capacity CCl₄ on a 7000 g-filter (in compliance with the efficiency level defined by the **standard AFNOR NFX 15-211**) or maximum rejection of 50% of the average exposure value of the product
- Please see the ventilation chapter for the detailed sheet of the filtering fresh air box in compliance with the standard NFX 15-211

→ SERIES ECO F

CODE	DESCRIPTION	EXTERNAL DIMENSIONS (WxDxH) mm	INTERNAL DIMENSIONS (WxDxH) mm	INTERNAL EQUIPMENT	STORAGE CAPACITY*	Weight (kg)
CF4TEO-103GP	Cabinet Series ECOF6 Cabinet with 1 glass door	600x600x1950	595x567x1864	4 shelves made of painted steel (max load 60 Kg evenly distributed) + 1 retention tray with grid made of painted steel and absorbent mat	170	95
CF8TEO-106GP	Cabinet Series ECOF12 Cabinet with 2 glass doors 2 compartments	1140x600x1950	503+503x567x1864	4 shelves made of painted steel (max load 60 Kg evenly distributed) + 1 retention tray with grid made of painted steel and absorbent mat per compartment	350	180
CF4TEO-104/2CV	Cabinet Series COMBICHEM F 2C Cabinet with 2 glass doors 2 superimposed compartments	600x600x1950	595x567x930+930	2 shelves made of painted steel (max load 60 Kg evenly distributed) + 1 retention tray with grid made of painted steel and absorbent mat per compartment	210	115
CF4TEO-104/2C	Cabinet Series COMBICHEM F 2C Cabinet with 2 plain doors 2 superimposed compartments	600x600x1950	595x567x930+930	2 shelves made of painted steel (max load 60 Kg evenly distributed) + 1 retention tray with grid made of painted steel and absorbent mat per compartment	210	110

*Approximate capacity in bottles holding 1 litre per cabinet

→ INTERNAL EQUIPMENT (OPTIONAL)

CODE	DESCRIPTION	DIMENSIONS (WxDxH) mm	RETENTION VOLUME (LITRES)	STORAGE CAPACITY*
RIPCS60	Fixed shelf made of painted steel for cabinet with 1 door	485x545x34	9	35
RIPX60	Fixed shelf made of painted steel for cabinet with 1 door	485x545x34	9	35
RIP60SC	System for sliding shelf - factory assembly	-	-	-
VACS60	Retention tray made of painted steel for cabinet with 1 door	485x545x70	18	35
COPCS60	Grid made of painted steel for cabinet with 1 door	485x545	-	35
CS-ABS	Absorbent paper - set of 4 sheets 50x40 cm	-	-	-
ALARME	Alarm system "open doors"	-	-	-

*Approximate capacity in bottles holding 1 litre

→ VENTILATION

CODE	DESCRIPTION	DIMENSIONS (WxDxH) mm
CFN	Fresh air box with molecular filtration according to standard NFX15-211, with visual and acoustic alarm supplied along with the cabinet	550x500x220
EOAS	Activated charcoal filter for solvents (pre-filter included)	510x405x60
EOBE	Activated charcoal filter for acids (pre-filter included)	510x405x60
EOMP	Activated charcoal filter for solvents and acids (pre-filter included)	510x405x60
EOPF	Pre-filter	510x405x15

*To obtain the complete list of the connection accessories, see the chapter on ventilation of this catalogue and the current price list

Hoods CHEMIHOOD PLUS with molecular filtration

Certified according to NFX15-211

Hoods with molecular filtration



The safest
and cheapest system
to handle chemicals



CHSCASPE120



CSF-003P



CSF-002P

→ HOW DOES A FUME HOOD WORK?

Hoods CHEMIHOOD PLUS provide the users with a safe working area to handle chemicals.

Easier and cheaper to use than those of chimney extractors, this system allows the extraction of noxious vapours with no need of external connections and without any issue relating to air compensation inside the room. Equipped with filters dedicated to specific applications, they comply with the most demanding standards in the world: STANDARD AFNOR NFX 15-211. CHEMIHOOD PLUS hoods, enclosure of class II, have been tested according to standard NFX 15-211 by an independent lab and certified according to the supervising office AJA Europe.

→ TECHNICAL FEATURES OF THE FRESH AIR BOX WITH FILTRATION:

- Electrogalvanized steel structure 10/10 mm, covered in a grey epoxy paint RAL 7035
- Axial fan (turbine)
- Flow rate: 100/250 m³/h
- Voltage/frequency: 220 volts/50Hertz
- IP44
- Acoustic level 45dB
- Complying with the standard ISO 3744
- ON/OFF switch with light indicators for proper working. Working hour meter with LED visual and acoustic indicator
- Filter saturation indicator with LED visual and acoustic indicator: speed measurement of the air passing through the activated charcoal filter
- Retention capacity CCl₄ on a 7000g-filter (in compliance with the efficiency level defined by the standard AFNOR NFX 15-211) or maximum rejection of 50% of the average exposure value of the product
- Filter should be chosen according to the handled products
- Optional sample draw pump by means of colorimetric check
- Please see the ventilation chapter for the detailed sheet of the fresh air box with filtration in compliance with the standard NFX 15-211

A saturated filter is an inefficient filter

To protect personnel and environment, change your filters regularly!

You can also test the filter saturation by means of a colorimetric check using a suction pump. Please feel free to contact us.



CSPO

→ TECHNICAL FEATURES OF HOODS:

- Completely made of "optical" methyl methacrylate with a thickness of 8 mm, CHEMIHOOD PLUS hoods provide an optimal, bright vision without distortions
- Tilted front side (7°) - ergonomic position at the work place
- Front panel can be totally lifted and blocked, so that access is easier in case of voluminous equipment, chemicals or cleaning operations
- Two lids to allow the passing of arms for easy handle ensuring the utmost safety
- Possibility of inserting of electric cables and fluids inside the enclosure through the cable ducts on the sides
- Retention tray made of stainless steel to recover liquids in the event of accidental spillage
- Possibility of adding a work surface made of enamelled glass or HPL with a thickness of 6 mm
- Available in three widths: 600 mm, 900 mm and 1200 mm
- Possibility of placing the hood on a mobile base with or without shelf
- Equipped with a filtering fresh air box complying with the standard AFNOR NFX 15-211 (filter should be chosen according to the stored products)

→ HOTTES CHEMIHOOD PLUS

CODE	DESCRIPTION	EXTERNAL DIMENSIONS (WxDxH) mm	INTERNAL DIMENSIONS (WxDxH) mm	INTERNAL EQUIPMENT	Weight (kg)
CSF-001P	Filtering Fume hood W600 mm certified according to standard NFX15-211, with acoustic and visual alarm	600x600x1000	584x584x800	1 retention tray made of stainless steel	41
CSF-002P	Filtering Fume hood W900 mm certified according to standard NFX15-211, with acoustic and visual alarm	900x600x1000	884x584x800	1 retention tray made of stainless steel	51
CSF-003P	Filtering Fume hood L1135 mm certified according to standard NFX15-211, with acoustic and visual alarm	1135x600x1000	1119x584x800	1 retention tray made of stainless steel	57
CSF-001PLH	Filtering Fume hood W600 mm built according to standard NFX15-211	600x600x1000	584x584x800	1 retention tray made of stainless steel	41
CSF-002PLH	Filtering Fume hood W900 mm built according to standard NFX15-211	900x600x1000	884x584x800	1 retention tray made of stainless steel	51
CSF-003PLH	Filtering Fume hood L1135 mm built according to standard NFX15-211	1135x600x1000	1119x584x800	1 retention tray made of stainless steel	57

→ EQUIPEMENTS INTERNES (en option - le choix d'un filtre est obligatoire)

CODE	DESCRIPTION	DIMENSIONS (WxDxH) mm
CSF-60E	Work surface made of toughened glass Emalit with a thickness of 6 mm (Hood width 600 mm)	584x584x6
CSF-90E	Work surface made of toughened glass Emalit with a thickness of 6 mm (Hood width 900 mm)	884x584x6
CSF-120E	Work surface made of toughened glass Emalit with a thickness of 6 mm (Hood width 1135 mm)	1119x584x6
CSF-60H	Work surface made of HPL laminate with a thickness of 6 mm (Hood width 600 mm)	584x584x6
CSF-90H	Work surface made of HPL laminate with a thickness of 6 mm (Hood width 900 mm)	884x584x6
CSF-120H	Work surface made of HPL laminate with a thickness of 6 mm (Hood width 1135 mm)	1119x584x6
CHSCASP60	Base on wheels without shelf for Hood width 600 mm	605x605x865
CHSCASP90	Base on wheels without shelf for Hood width 900 mm	900x605x 865
CHSCASP120	Base on wheels without shelf for Hood width 1135 mm	1140x605x 865
CHSCASPE60	Base on wheels with shelf for Hood width 600 mm	605x605x865
CHSCASPE90	Base on wheels with shelf for Hood width 900 mm	900x605x 865
CHSCASPE120	Base on wheels with shelf for Hood width 1135 mm	1140x605x 865
PE100	Wall socket for wall panelling under the base	-
HOOD/LUM	External lighting	-
EOAS	Activated charcoal filter for solvents (pre-filter included)	510x405x60
EOBE	Activated charcoal filter for acids (pre-filter included)	510x405x60
EOMP	Activated charcoal filter for solvents and acids (pre-filter included)	510x405x60
EOPF	Pre-filter	510x405x15
CSPO	Suction manual pump for colorimetric check	-
CSPO/AA	Kit of 10 colorimetric tubes - Ac. Acid 1-80 ppm - for corrosion test*	-
CSPO/AC	Kit of 10 colorimetric tubes - Acetone No. 151 - for organic test*	-

*There are other colorimetric tubes available: please feel free to contact us

Hoods CHEMIHOOD with connection

Certified according to standard EN61010-1



EOF-001+CHSCA60

The economic solution to handle small quantities of chemicals safely



→ TECHNICAL FEATURES:

- Hood body comprising a moulded board made of acrylic methacrylate with front opening to access the volume of work.
- Motor housing made of electrogalvanized cold pressed and bent, then painted steel sheet EF P01 with a thickness of 10/10mm
- Antistatic extraction motor made of polyamide and reinforced fiberglass, resistant to corrosion
- Extraction rate: 200³/h max
- Electric power supply: 220/230V - 50Hz
- Outlet diameter of 125 mm
- Internal thermal protection IP44 according to standard DIN40050
- Protective fuse 5x20 mm, 1A
- Absorption 31W
- Alternative solution with filters HEPA and activated charcoal as standard
- Standardized pictogram signalling according to the use of hazardous substances

→ HOODS CHEMIHOOD

CODE	DESCRIPTION	EXTERNAL DIMENSIONS (WxDxH) mm	INTERNAL DIMENSIONS (WxDxH) mm	OPENING DIMENSIONS (WxH) mm	Weight (kg)
EOF-001	Fume hood W600 mm	600x600x500+300 (motor)	550x550x500	440x480	35
EOF-002	Fume hood L1200 mm	1200x600x500+300 (motor)	1150x550x500	800x480	45
EOF-004	Fume hood W600 mm with filter HEPA and activated charcoal	600x600x500+300 (motor)	550x550x500	440x480	35
EOF-003	Fume hood L1200 mm with filter HEPA and activated charcoal	1200x600x500+300 (motor)	1150x550x500	800x480	45

→ INTERNAL EQUIPMENT (optional)

CODE	DESCRIPTION	DIMENSIONS (WxDxH) mm
CSH004	Work surface made of stainless steel for hood 600 mm	550x550x40
CSH004V	Work surface made of stainless steel for hood 1200 mm	550x550x40
CSH005	Work surface made of painted steel for hood 600 mm	1150x550x40
CSH005V	Work surface made of painted steel for hood 1200 mm	1150x550x40
CHSCA60	Base on wheels two of which are auto-locking with laminated work surface made for hood 600 mm	750x650x870
CHSCA120	Base on wheels two of which are auto-locking with laminated work surface made for hood 1200 mm	1200x650x870
CSH002	Activated charcoal filter for hood 600 mm	-
CSH003	Activated charcoal filter for hood 1200 mm	-
CSH007	Filter HEPA	-
GFKIT125	Kit of connections comprising 1 meter of hose, diam. 125 mm and 2 attachment clamps	Ø125 mm

Storage of phytosanitary products

Decree no 87-361 of 27 May 1987: Regulation

Article R.5162 of the Public Health Code foresees that all phytosanitary products should be stored in a room:

- used for this purpose
- separately from food products for the human or animal diet or from other hazardous substances
- key locked so that no foreign person, above all children, can access the room
- aerated and ventilated
- free of moisture



→ REMINDER OF THE SAFETY RULES CONCERNING THE STORAGE OF PHYTOSANITARY PRODUCTS

The storage of phytosanitary products far from water courses and points, sensitive crops, inhabited areas, areas of food storage (food for animals, greens...), areas with a high concentration of persons, power lines.

Provide for easy access to the room by delivery vans and for waste disposal.

The storage area for phytosanitary products might be a bungalow, a container or a safety cabinet. They should be:

- aerated and ventilated
- key locked (article 4 of the Decree 97-361 of 27 May 1987)
- the door should open outwards
- the ground should be waterproof (retention floors, retention pallets, retention bins), lighting should be appropriate
- the electrical system should be in compliance with the standard NFC.15.100
- provide the door of the bungalow, container or cabinet with a sign indicating all safety instructions, standardized hazard pictograms... (Article R.232-12-14 of the Labour Code and Article 10 of the Decree 87-361 of 27 May 1987)
- provide for a fire extinguisher outside the stocking area (article R. 232-12-17 of the Labour Code) and a suitable first aid kit (article R. 232-1-6 of the Labour Code)
- provide for a stock of absorbent material in close proximity, should any accidental leakage or spillage occur

→ HOW TO STORE THE PHYTOSANITARY PRODUCTS PROPERLY

- Store the products by family and keep incompatible products separated from each other (article R5132-68 of the Public Health Code).
- Identify and make an up-to-date list of the homologated products stored (article 3 of the decree 87-361 of 27 May 1987).
- Display all necessary information for prevention which appears on the safety data sheet (article R. 521-53 of the Labour Code).
- Store only materials which reserved for the phytosanitary use (article 5 of the decree 87-361 of 27 May 1987).
- Provide for enough absorbent materials (example: absorbent mat).
- Use grids to isolate the products of the retention tray.
- Provide the room with a first aid kit: eyewash equipment, first aid kit... (R. 232-16 of the Labour Code).
- Display the emergency numbers in close proximity (R. 521-53 of the Labour Code).
- Store empty packaging in a collection tank for treatment by a specialized company.
- Keep the personal protective equipment and the stock of filter cartridges in a specific room (article 8 of the decree 87-361 of 27 May 1987).
- Provide for an eyewash station and an emergency shower in close proximity but away from the storage area (R. 232-1-6 of the Labour Code).





→ DECREE NO. 87-361 OF 27 MAY 1987

- **Article 1:** «The provisions of this decree are applicable to the agricultural settlements mentioned in article L. 231-1 of the labour code».
- **Article 2:** «The employer is required to comply with any instruction of the labels which is prescribed as mandatory by the regulations for the application of article L. 231-6 of the labour code or article L. 626 of the public health code to ensure protection against the hazards caused by the use of pest control products».
- **Article 3:** «Pest control products should be stored inside their original packaging until their final use».
- **Article 4:** «Pest control products should be placed in a room devoted to this purpose. This room should be aerated and ventilated. It should be key locked if it contains pest control products that are classified as highly poisonous, poisonous, carcinogenic, teratogen or mutagenic. The key should be kept by the employer».
- **Article 5:** «Use only materials devoted to the use of pest control products. This material should not be used to supply surface or ground water which is necessary for dilutions. All tools used for this purpose should be kept inside the room mentioned in the above article 4».
- **Article 6:** «Since it is foreseen by the labelling to wear the above items, the employer should check that his employees wear the suitable protective equipment, above all during the preparation of boiled items, mixtures and during the application of products. The employer or his attendant should ensure proper working and suitable adjustment of both materials and protective equipment».
- **Article 7:** «The employer is in charge of the provision of materials and protective equipment. He makes sure of their maintenance and periodic replacement, as well as in case of defect. Protection equipment should be washed with water added with a suitable product».
- **Article 8:** «Notwithstanding the provisions of article R. 232-24 of the labour code, protective equipment should be placed, after cleaning, in a cupboard devoted to this sole purpose and located in another room other than that mentioned in the above article 4».
- **Article 9:** «At the end of the preparation of boiled items and mixtures, the employer should ensure that his employees wash their hands and face. At the end of the application of products, he should ensure that his employees wash their body. A reserve of water and suitable detergents for immediate washing of stains should be kept in close proximity to the place where products are prepared and applied».
- **Article 10:** «The employer should not permit his employees to snort, smoke, drink or eat in areas exposed to pest control products and before washing their body».
- **Article 11:** «The application treatments of pest control products should be carried out in order to prevent the wind from blowing them against the workers».

Series PHYTO

Storage cabinets for pest control products
and other agricultural products



K89112CP



K89111CP

Handy
and cheap



K89116CP



K89115CP

→ TECHNICAL FEATURES:

- Strong structure made of steel, covered in a green epoxy paint RAL 6010.
- Steel 8/10°.
- Swing doors with single wall.
- Safety key lock with 3 points for protection against theft.
- Retention shelves made of painted steel, height-adjustable.
- Prearrangement for ventilation through a Ø 125 mm flange for connection.
- Complying with the provisions of the **public health code**: articles R.5162 et R5170.
- Standardized pictograms according to **standards ISO 3864**

→ SERIES PHYTO

CODE	DESCRIPTION	EXTERNAL DIMENSIONS (WxDxH) mm	INTERNAL DIMENSIONS (WxDxH) mm	INTERNAL EQUIPMENT	STORAGE CAPACITY*	Weight (kg)
K89112CP	High cabinet with 1 door	540x450x2000	530x430x1980	3 shelves + 1 retention tray made of painted steel (max load 60 kg evenly distributed)	48	45
K89111CP	High cabinet with 2 doors	1000x450x2000	990x430x1980	3 shelves + 1 retention tray made of painted steel (max load 80 kg evenly distributed)	96	65
K89116CP	Cabinet counter with 1 door	5400x450x1000	530x430x998	3 shelves + 1 retention tray made of painted steel (max load 60 kg evenly distributed)	24	35
K89115CP	Cabinet counter with 2 doors	1000x450x1000	990x430x998	3 shelves + 1 retention tray made of painted steel (max load 80 kg evenly distributed)	48	45

*Approximate capacity in bottles holding 1 litre per cabinet

→ INTERNAL EQUIPMENT (optional)

CODE	DESCRIPTION	DIMENSIONS (WxDxH) mm	RETENTION VOLUME (LITRES)	STORAGE CAPACITY*
CRF600V	Additional shelf made of painted steel for cabinet with 1 door	530x415x30	6	12
CRF900V	Additional shelf made of painted steel for cabinet with 2 doors	990x415x30	12	24

*Approximate capacity in bottles holding 1 litre

→ VENTILATION (optional)

CODE	DESCRIPTION	DIMENSIONS (WxDxH) mm
DIAM125BP	Fresh air box with filter holding box for high cabinet with 1 or 2 doors- inlet/outlet Ø: 125 mm (filter excluded)	290x290x270
RE1000	Fan flow controller (to be ordered with the fan K89013)	-
K89007	Activated charcoal filter for motor DIAM125BP - (replacement twice every year minimum)	235x110x15
GFKIT125	Connection kit: 1 metre of flexible sheath Ø125 mm and 2 clamps	Ø 125 mm
TIM24	Daily counter	-

* To obtain the complete list of the connection accessories, see the chapter on ventilation of this catalogue and the current price list

Ventilation Choice Guide

The importance of filter replacement

→ THE CHOICE OF VENTILATION

In order to ensure the utmost safety of workers and to preserve the safety cabinets for corrosive substances, we recommend to provide them with a ventilation system.

For networks longer than 5 metres, please contact us: we will provide you with a customized study

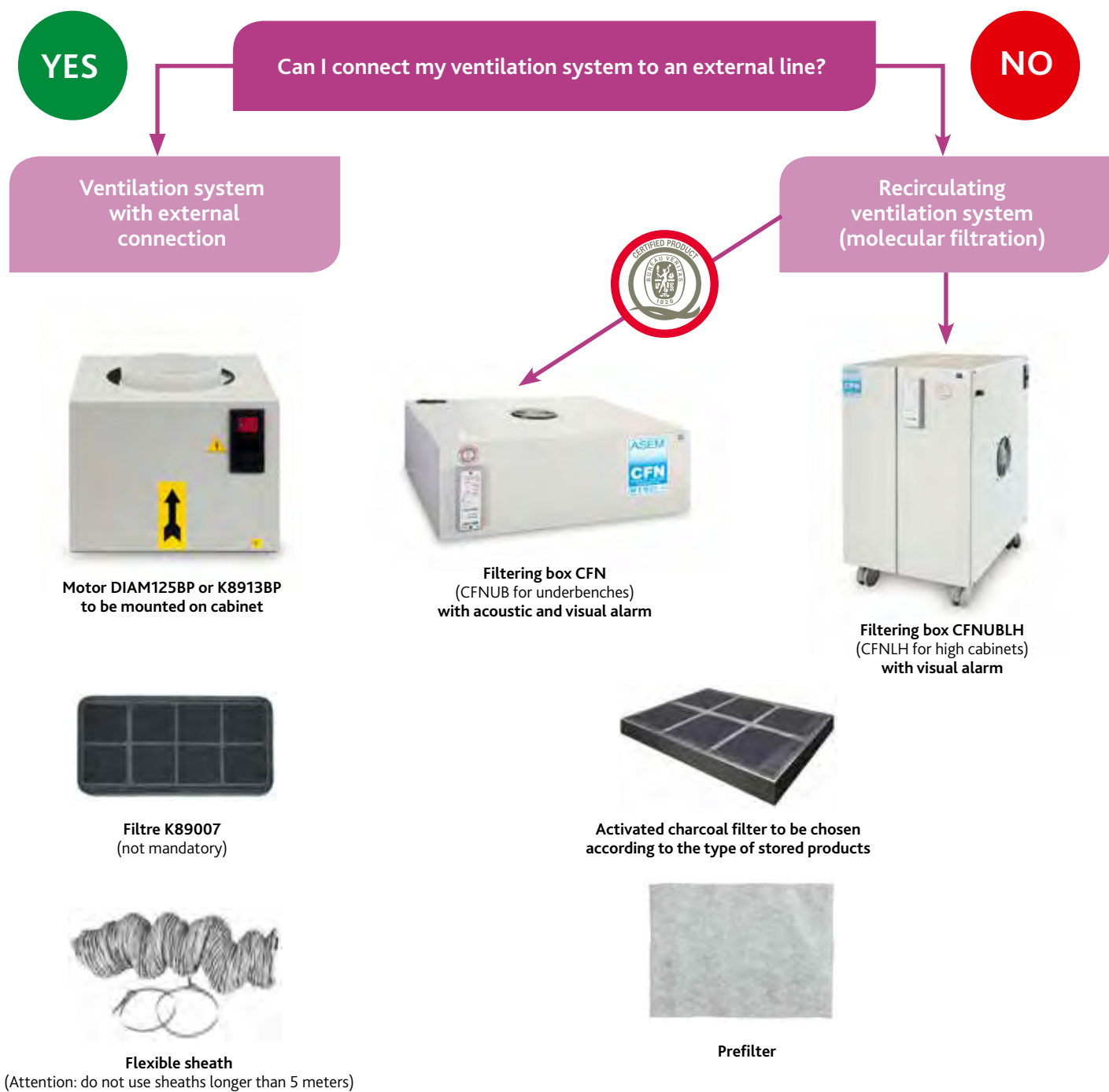

→ REPLACEMENT OF ACTIVATED CHARCOAL FILTERS

Activated charcoal is a microporous absorbent substance belonging to a network of fissures and pores connected to each other, which is present throughout the whole material.

Contaminant gas molecules contained in an air flow penetrate through the largest pores situated on the surface of the activated charcoal by means of a process called diffusion and move towards the inner surface of the narrowest pores. When a gas molecule hits the surface of the activated charcoal in a suitable point, an attraction occurs and the molecule gets entrapped.

Therefore, a filter is saturated when all the pores are filled with the substance to be filtrated. It becomes then inefficient and worse, **the first entrapped molecules are released by the pressure of the new molecules.**

The role of the filters inside fresh air boxes of cabinets is to hold noxious vapours that are released by the stored products inside the cabinet itself.

It is extremely important to **replace filter on a regular basis**, or at least to check their saturation level.

Ventilation system with connection



Ventilation system with recirculation



→ REFERENCES:

- For cabinets containing solvents: Motor DIAM125BP + filter K89007 + connection kit GFKIT100
- For cabinets containing chemicals: Motor K8913BP + filter K89007 + connection kit GFKIT125
- In a system with external connection, the filter is not mandatory, his purpose is basically to protect the environment.
- WE RECOMMEND TO REPLACE THE FILTER 2 TO 3 TIMES A YEAR AND TO PERFORM MAINTENANCE MONTHLY (cleaning of cabinet, dust-removal of the filter)

→ REFERENCES:

- Motor CFN or CFNLH + filter EOAS/EOBE/EOMP according to the type of stocked products
- WE RECOMMEND TO REPLACE THE FILTER 2 TO 3 TIMES A YEAR
- It is also possible to check the filter saturation through a colorimetric check carried out using a suction pump. Please feel free to contact us.



A saturated filter is an inefficient filter

In order to protect workers and environment, replace the filters on a regular basis!

It is also possible to check the filter saturation through a colorimetric check carried out using a suction pump. Please feel free to contact us.



REPLACE FILTERS ON A REGULAR BASIS AND CHECK THEIR SATURATION

VENTILATION UNITS with external connection

For cabinets containing
non-flammable chemicals



K89190

→ TECHNICAL FEATURES:

- Chamber made of reinforced fiberglass and polyamide resin
- Filter holding box included in the motor body
- Flameproof
- Antistatic
- Corrosion resistant
- Internal thermal protection IP44 according to standard DIN40050
- Extraction rate: 260 m³/h
- Electrical power supply: 220-230V/50HZ single phase
- Supplied with power supply cable
- Neoprene gasket to ensure
- Outlet diameter: 125 mm

Clogged filter = no efficient filtration of chemicals = lack of protection for workers

**As safety and health have no price,
check and replace filters on a regular basis**

The filtration box should include an activated charcoal filter

→ SERIES

CODE	DESCRIPTION	DIMENSIONS (WxDxH) mm	Weight (kg)
DIAM125BP	Fresh air box with filter holding box for high cabinet containing chemicals - outlet Ø: 125 mm (filter excluded)	290x290x270	10
K89190	Fresh air box with paneling for cabinet with 1 door - outlet Ø 125 mm	600x600x300	14
K89191	Fresh air box with paneling for cabinet with 2 doors - outlet Ø 125 mm	1140x600x300	18

→ OPTIONS

CODE	DESCRIPTION	DIMENSIONS (WxDxH) mm
RE1000	Fan flow controller	-
K89021	Activated charcoal filter for fresh air box K89190-K89191- (replacement twice a year minimum)	300x240x15
K89007	Connection kit : 1 metre of flexible sheath Ø 125mm and 2 clamps	235x110x15
GFKIT125	Kit de raccordement : 1 mètre de gaine souple Ø 125mm et 2 colliers de fixation	Ø 125 mm - W1000 mm
GF125	1 metre of flexible sheath Ø 125 mm	Ø 125 mm - W1000 mm
SERMET125	Clamp Ø 125 mm	Ø125 mm
AC409	Rigid PVC pipe Ø 125 mm	Ø125 mm - W1000 mm
AC419	Rigid PVC 90° elbow Ø 125 mm	Ø 125 mm
AC429	Rigid PVC 45° elbow Ø 125 mm	Ø 125 mm
AC440	Rigid PVC T-connection Ø 125 mm	Ø 125 mm
AC489	Rigid PVC manual butterfly valve Ø 125 mm	Ø 125 mm
AC457	Expulsion section with anti-bird grid Ø 125 mm	Ø 125 mm
AUM100125	Reduction 125 mm/100 mm	Ø 125 mm - Ø 100 mm
TIM24	Daily counter	-

For cabinets containing inflammable chemicals

→ TECHNICAL FEATURES:

- Steel compartment with aluminium rotor
- Filter holding box included in the motor body
- Flameproof & antistatic
- Corrosion resistant
- Internal thermal protection IP55 according to standard DIN40050
- Extraction rate: 200m³/h
- Electrical power supply: 220-230V/50HZ single phase
- Integrated filtered compartment
- Supplied with power supply cable
- Neoprene gasket to ensure tightness
- Outlet diameter: 100 mm
- Available in ATEX version



DIAM125BP

→ ACTIVATED CHARCOAL FILTER

Activated charcoal is a microporous absorbent substance belonging to a network of fissures and pores connected to each other, which is present throughout the whole material.

Contaminant gas molecules contained in an air flow penetrate through the largest pores situated on the surface of the activated charcoal by means of a process called diffusion and move towards the inner surface of the narrowest pores.

When a gas molecule hits the surface of the activated charcoal in a suitable point, an attraction occurs and the molecule gets entrapped.

Therefore, a filter is saturated when all the pores are filled with the substance to be filtrated. It becomes then inefficient and worse, the first entrapped molecules are released by the pressure of the new molecules.

The role of the filters inside fresh air boxes of cabinets is to hold noxious vapours that are released by the stored products inside the cabinet itself.

It is extremely important to replace filter on a regular basis, or at least to check their saturation level.

→ SERIES

CODE	DESCRIPTION	DIMENSIONS (WxDxH) mm	Weight (kg)
DIAM125BP	Fresh air box with power supply cable and filter holding box (filter excluded) - outlet Ø 100 mm	290x290x270	11
EOF100ABPMY11	Fresh air box ATEX with power supply cable and filter holding box (filter excluded) - outlet Ø 100 mm	270x260x430	11

→ OPTIONS

CODE	DESCRIPTION	DIMENSIONS (WxDxH) mm
RE1000	Fan flow controller (to be ordered along with fan K89013)	-
K89007	Activated charcoal filter (replacement three times a year minimum)	235x110x15
GFKIT100	Kit for external connection (1 metre of flexible sheath Ø 100 mm and 2 clamps)	Ø 100 - W1000 mm
GF100	1 metre of flexible sheath Ø 100 mm	Ø 100 mm - W1000 mm
SERMET100	Clamp Ø 100 mm	Ø 100 mm
AC408	Rigid PVC pipe Ø 100 mm	Ø 100 mm - W1000 mm
AC425	Rigid PVC 90° elbow Ø 100 mm	Ø 100 mm
AC428	Rigid PVC 45° elbow Ø 100 mm	Ø 100 mm
AC488	Rigid PVC manual butterfly valve Ø 100 mm	Ø 100 mm
AC456	Expulsion section with anti-bird grid Ø 100 mm	Ø 100 mm
AC443	Rigid PVC T-connection Ø 100 mm	Ø 100 mm
AUM100125	Reduction 125 mm/100 mm	Ø 125 mm - Ø 100 mm
TIM24	Daily counter	-

Fresh air box with filtration

Certified according to standard NFX15-211



All toxic vapours released by the storage of chemicals are removed, thus ensuring cleaned air inside the lab.

Easier and cheaper to implement, this system allows the ventilation of cabinets with no need of external connections and with no issue relating to air compensation in the room.

Therefore this ventilated cabinet can be installed in any place of the lab and in close proximity to the work area.

→ WORKING PRINCIPLE OF A FILTERING VENTILATED CABINET

Noxious vapours remaining inside the storage cabinet are extracted by the fresh air box and cleaned when passing through the activated charcoal filter before being released into the atmosphere. The filtration of vapours should be performed in a specific manner by choosing the suitable activated charcoal filter.

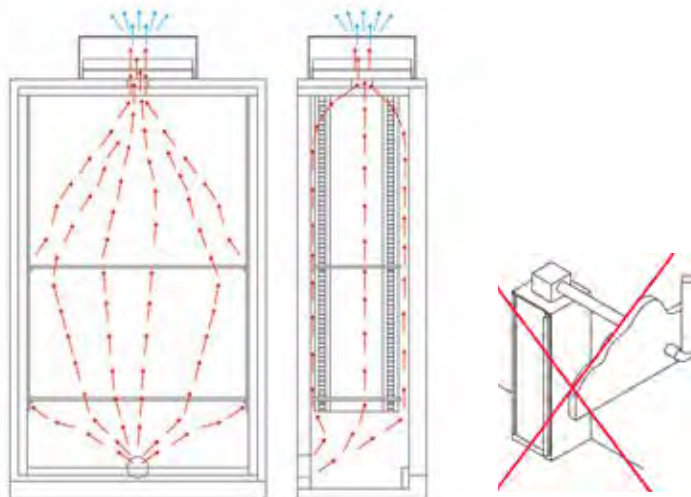

→ ACTIVATED CHARCOAL FILTER

Activated charcoal is a microporous absorbent substance belonging to a network of fissures and pores connected to each other, which is present throughout the whole material.

Contaminant gas molecules contained in an air flow penetrate through the largest pores situated on the surface of the activated charcoal by means of a process called diffusion and move towards the inner surface of the narrowest pores. When a gas molecule hits the surface of the activated charcoal in a suitable point, an attraction occurs and the molecule gets entrapped.

Therefore, a filter is saturated when all the pores are filled with the substance to be filtrated. It becomes then inefficient and worse, **the first entrapped molecules are released by the pressure of the new molecules.**

The role of the filters inside fresh air boxes of cabinets is to hold noxious vapours that are released by the stored products inside the cabinet itself.

It is extremely important to replace filter on a regular basis, or at least to check their saturation level.

Technical drawings

- Sizes: W550 x D500 x H200 mm
- Weight : 13 Kg

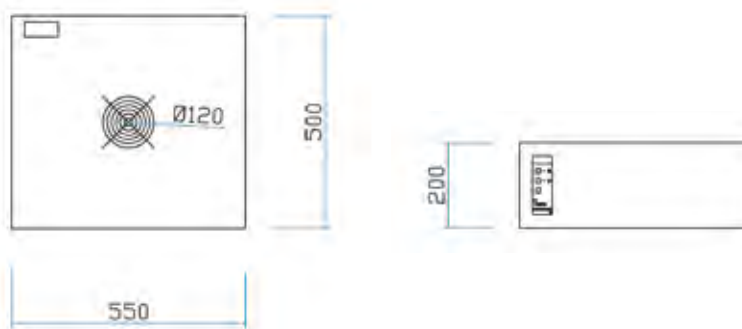

→ TECHNICAL FEATURES:

Cabinet ventilation

- Electrogalvanized steel structure 10/10 mm, covered in a grey epoxy paint RAL 7035
- Axial fan
- Flow rate: 100 to m³/h
- Voltage/frequency: 220 volts/50Hz, protection IP44
- Acoustic level 45dB
- Complying with the standard ISO 3744
- Retention capacity CCL4 on a 7000g-filter (in compliance with the efficiency level defined by the standard AFNOR NFX 15-211) or maximum rejection of 50% of the average exposure value of the product)



Control Microprocessor AC5500

- ON/OFF switch with light indicators for motor proper working
- LED visual and acoustic working hour meter
- Alarm indicator of filter saturation every 60 working hours
- Speed measurement of the air passing through the filter
- Possibility of programming the suction time (12h or 24h)



Manual sampling pump (optional)

- It allows air sampling and the colorimetric analysis in order to assess the activated charcoal filter saturation.

**Clogged filter = no efficient filtration of chemicals
= lack of protection for workers**

**As safety and health have no price,
check and replace filters on a regular basis**

The filtration box should include an activated charcoal filter



→ FRESH AIR BOX WITH FILTRATION

CODE	DESCRIPTION	DIMENSIONS (WxDxH) mm
CFN	Fresh air box with molecular filtration according to standard NFX15-211, with visual and acoustic alarm	550x500x220
CFNLH	Fresh air box with molecular filtration with hour meter, built according to standard NFX15-211	550x500x220
CFNUB	Certified box with filtration certified according to standard NFX15-211 for underbench cabinets, provided with wheels, 2 ventilation outlets, with acoustic and visual alarm.	400x500x650
CFNUBLH	Box with filtration built according to standard NFX15-211 for underbench cabinets, provided with wheels, 2 ventilation outlets	400x500x650
ADCFNMY11	Adapter for CFN box for fireproof cabinet	595x500x80
ADMY11CFN	Adapter for CFN box for cabinet C3 and C4 (EO343-342-344MY11)	-
EOAS	Activated charcoal filter for solvents (pre-filter included)	510x405x60
EOBE	Activated charcoal filter for acids (pre-filter included)	510x405x60
EOMP	Activated charcoal filter for solvents and acids (pre-filter included)	510x405x60
EOSP	Activated charcoal filter on request	510x405x60
EOPF	Prefilter	510x405x15
CSPO	Suction manual pump for colorimetric check	-
CSPO/AA	Kit of 10 colorimetric tubes - for corrosion test*	-
CSPO/AC	Kit of 10 colorimetric tubes - for organic test *	-

*There are other colorimetric tubes available: please feel free to contact us

SAFETY SHELVING made of modular epoxy steel

Please feel free to contact us
to work on your project together



→ TECHNICAL FEATURES:

- Strong and modular structure made of galvanized steel, covered in a nontoxic and anti-scratch epoxy resin.
- Standard colour: RAL7035
- Perforated shelves made of polypropylene, corrosion resistant
- High capacity: permitted maximum load per shelf: 150 to 205 kg evenly distributed according to the shelf width
- Standard models H2000 mm with 4 shelves
- Optional retention tray
- Optional wall mounting system
- Robustness and quality: product solidity during the whole production line

Patented self-locking attaching system
allowing an easy and quick assembly
with just one worker,
with no need of screws and tools

→ MAXIMUM HYGIENE



- Ideal for use in the food, chemical, pharmaceutical and hospital sectors
- Very easy withdrawal of shelves
- Shelves can be washed in the dishwashing machine, thus ensuring the utmost hygiene
- Complying with the standard HACCP



→ MODULAR SHELVING

	BASE ELEMENT - H2000 mm			NEXT RIGHT ELEMENT - H2000 mm		
	W900 mm	W1000 mm	W1200 mm	W850 mm	W950 mm	W1150 mm
D400 mm	AF3LSF4820	AF3LSF4920	AF3LSF41120	AF3LEF4820	AF3LEF4920	AF3LEF41120
D500 mm	AF3LSF5820	AF3LSF5920	AF3LSF51120	AF3LEF5820	AF3LEF5920	AF3LEF51120
D600 mm	AF3LSF6820	AF3LSF6920	AF3LSF61120	AF3LEF6820	AF3LEF6920	AF3LEF61120

Other sizes on request

TRUST US WITH YOUR PROJECT!



Our design department is at your disposal to optimize the available space and fulfil your standard or custom-made orders..

- Pre assembly of ladders according to the customer's requirements
- Use-friendly labelling thanks to a label showing the content and references of the project
- Space optimization by removing the uprights from angles

Please feel free to contact us to work on your project together

SAFETY SHELVING non modular aluminum



Code : EO950

→ TECHNICAL FEATURES:

- Aluminium structure
- Sizes: 1125 x 500 x 1830 (W x D x H)
- Weight: 22 kg approx.
- 4 retention shelves allowing the recovery of chemicals in the event of accidental spillage
- Retention shelves for the chemical recovery in case of accidental reversal
- Number of shelves: 4 maximum
- Retention capacity: 13 litres
- Shelving equipped with levelling jacks

GENERAL CONDITIONS OF SALE

September 2017

GENERAL INSTRUCTIONS

- 1 - The placing of orders implies the purchaser's acceptance of these general conditions of sale. The nullity of one of these general conditions of sale will not affect the validity of all other conditions.
- 2 - All clauses imprinted adjacent hereto or in the body of letters or the purchase orders of the purchaser, that are contrary to these general conditions of sale, may not be enforced against us, unless this has been accepted in writing on our part.
- 3 - Equipment and materials that we produce and supply are for users of hazardous substances under the sole liability of users. Our products comply with the French and European standards in force. Should customers decide to use these products outside the European Union, they need to check the compliance with the regulations of the destination country. We accept no liability for improper use other than the original one by the users or in case of non-compliance with the local standards

PRODUCTS AND CATALOGUE

- 1 - Features, dimensions, weights, colours, photos and information contained in the catalogue, prices and notes are just indicative and do not place us under any obligation. We reserve the right to modify, without notice, our materials, both in aspect and size, with no change in their intrinsic quality. All technical specifications contained in our current catalogue cancel and replace those published previously. Despite our efforts, some errors may escape our attention. The customer could not assert against us that he was not aware of this. According to article 18 of the decree 2005-829 dealing with the composition of electrical and electronic equipment and the disposal of wastes due to this equipment, all liabilities relating to the organisation and funding of waste removal and treatment are transferred to the customer and he shall be deemed responsible for that.
- 2 - Technical researches and recommendations have been done voluntarily and are indicative. They do not incur the liability of ASEM® and do not constitute an element of execution. It is the users' responsibility to verify them and check their compliance with the applicable general rules for this kind of execution, as well as with particular conditions of employment.

PRICES AND ORDERS

- 1 - Prices or offers specified in our catalogue and price lists are valid at the time of printing and distribution. They cancel and replace all offers and prices specified previously. All prices are shown exclusive of taxes, in Euros, EX WORKS (Italy I-31032), unless otherwise notified in writing and subject to a significant increase in raw materials and/or currencies. For all shipments, the minimum amount of a bill is 100 Euros, excluding taxes. For order below this amount, a flat billing rate of 20 Euros excluded taxes will be applied.
- 2 - Orders should be sent to us in writing (e-mail, telefax or mail) according to our catalogue and current prices or quotation to the client. Orders shall be placed only upon acceptance and validation by ASEM®, on the acknowledgment of receipt by the seller. All claims concerning the conditions of execution of orders shall be presented upon receipt of the acknowledgment of receipt, before delivery.
- 3 - All orders are firm and irrevocable for the Purchaser from the acceptance by ASEM®.

No order shall be cancelled by the Purchaser, unless prior consent by the Seller, and in this case, the Seller reserves the right to claim, as compensation, the amount of the purchased or work-in-progress goods.

DELIVERY TIMES

- 1 - The dates of product availability noted on our acknowledgment of order receipt and on our quotation are given in good faith but without any claim for compensation or cancellation resulting therefrom if not met.

- 2 - Our delivery dates start from the date of the acknowledgment of order receipt.
- 3 - Stipulations concerning orders and specifying for example the penalties for late delivery or others might be applied only upon our nominative acceptance in writing.
- 4 - If the purchaser is not able to receive our delivery on the availability date indicated on the acknowledgment of order receipt, we will take all necessary measures to store the goods under the best possible conditions. The corresponding fees will be charged to the purchaser. Delivery shall be made only if the customer is up to date with his obligations towards our company and if the particular conditions accepted by the customer and ASEM® are met.

TRANSPORT AND DELIVERY

- 1 - Unless otherwise agreed in writing, our products are sold EX WORKS Italy (I-31032).
- 2 - ASEM® assumes responsibility for the necessary packaging to prevent all damages under normal transport conditions. If ASEM® assumes responsibility for the arrangement of the transport agreement, shipping fees will be invoiced additionally and transport will be carried out for the best interests of the customer but without any commitment or liability by ASEM France. In order to know the transport fees, please refer to the quotation drawn up by ASEM® or the Price List 2015. The customer shall inform about any limitation and/or restriction that would not allow the carriers to perform their task correctly.
- 3 - Our goods travel at the recipient's risks (art. L133-3 of the Commercial Code). The recipient of goods undertakes, upon receipt, to:
 - a/ check the conditions and quantity of the received goods by opening packages in the presence of the deliverer and before signing the carrier's dispatch note or delivery note.
 - b/ enter precise reservations, in the event of damage or missing products, on the transport receipt specifying their nature in a very detailed manner.
 - c/ notify carrier of any damage or missing product by registered letter with acknowledgement of receipt within 48 hours after the date of receipt of the goods, in compliance with article L 133-3 of the Commercial Code.Failure to respect these instructions prevents all actions against the Seller and the Carrier.
- 4 - For any goods delivery, refused without a valid reason or impossible to carry out for various reasons: wrong address, inadequate buildings, lack of a responsible receiving person, non-compliant delivery time, or any other circumstance beyond our control, the price of the new delivery of goods will be invoiced again.
- 5 - Installation and construction prices are not included in our offer, unless previously agreed, and will be the object of a complementary quotation.
- 6 - Goods remain the property of ASEM® until the price has been paid in full, but the Purchaser will become liable only upon delivery of goods or their installation.

LACK OF CONFORMITY AND CLAIMS

- 1 - All claims concerning a lack of conformity to the order (model, delivered quantity, damaged product) should be notified by registered letter with acknowledgement of receipt within 7 days after the date of receipt of goods. Using the goods entails the waiver by the Purchaser of all claims for lack of conformity.

2 - No return of goods will be accepted without prior authorization by the Seller. Return, prior agreement with ASEM®, shall be carried out at the expense and risk of the Purchaser in the original package. Returned goods will give rise to a credit note after checking their perfect conditions. A flat discount of 25% will be applied over one month.

3 - Returned goods shall be only standard models. ASEM® will not accept any custom-made product.

WARRANTY

The warranty shall start as of the delivery date of goods (Invoice in lieu of warranty) and does not include consumable parts or routine maintenance and adjustments indicated in the user's guides supplied together with the equipment.

Our warranty applies only in case of defects in conception or a hidden defect and is strictly limited to the replacement of materials and components recognised as faulty by our quality and technical service, the only qualified to judge.

This warranty shall not be applied in the event of storage, use or maintenance by the user non complying with the use or instructions for use or if goods have been damaged by the user or third parties or if the goods have been modified or repaired by the user or third parties without our authorization in writing, nor in case of normal wear or in case of non-payment of all or part of the cost of materials on the due date. The warranty appliance will not have the effect of extending its term. Our warranty ceases if the purchaser fails to notify the noted defect within 7 days after the date of detection, which date he should be able to prove.

Warranty does not include:

- Normal wear of the product,
- Use of consumable parts of other brands,
- Product transformation or incompatibility with other materials,
- Improper or non-compliant use of the product with regard to its specifications or negligent storage or maintenance carried out by the customer,
- Improper installation of the product,
- Damages caused by corrosion.

1 - Safety cabinets: the warranty period is THREE YEARS for cabinets with ventilation and ONE YEAR for cabinets without ventilation.

2 - Ventilation units and filtering boxes: the warranty period is ONE YEAR.

ASEM® reminds that for ventilation units DIAM125BP, EOF100ABPMY11, K89013BP, K89190 and K89191, the warranty applies only if they are provided with an external connection by means of a sheath or pipe supplied by the Customer or by ASEM®.

ASEM® also reminds that:

- If necessary, filters should be replaced every 3 to 4 months in case of regular use.
- filters should be replaced immediately in case of accidental spillage of a "so called hazardous" substance inside the cabinet.
- Cabinets should be placed in a clean and aerated room.
- Cabinets should be cleaned (maintenance, dust removal,...)

We recommend following the instructions provided on the maintenance sheet and applying the described procedure for dust removal of the filter.

3 - Fume and connected hoods: the warranty period is ONE YEAR.

4 - Emergency shower and others: the warranty period is ONE YEAR.

ASEM® declines all liabilities in case of improper use of the supplied goods other than the original one. The users are solely responsible for any handling, experiences gained and handled products (toxic, radioactive

or inflammable) by means of the equipment by ASEM®. These users shall pay the utmost care when using such products in order to comply with legal requirements, particularly as regards personnel safety, and provisions relating to health and safety at work and accident prevention

INTELLECTUAL PROPERTY

Photographs, diagrams, logos and texts shown on our commercial documents in paper or digital form, including websites, registered or not at an Intellectual property office, are the exclusive property of ASEM®. Any infringement of the intellectual property will result in legal proceedings. All brands and logos shown and mentioned in our technical and commercial documents are filed and belong to their respective owner.

PAYMENT CONDITIONS

1 - Sales in France & overseas territories and departments: goods shall be paid within 30 days at the latest by cheque, bank transfer or accepted and domiciled bill (if not otherwise agreed and confirmed on quotation previously).

Equipment sold to a new customer is payable in cash as first order.

The items addressed to the customer must return to ASEM®, whether accepted or not, under pain of being sued for damages..

2 - Export sales: all settlements corresponding to exported products beyond French borders will be performed as follows:

- For the first order: 100% pre-payment or documentary remittance versus payment.
- Invoice amount higher than 10.000 Euros exclusive of taxes: 100% by irrevocable and confirmed documentary credit, payable within 10 days after LTA or BL against presentation of documents to your bank.

PAYMENT DELAY

According to article L441-6 of the Commercial Code, any payment delay will result, at the supplier's discretion and from the first days of delay, in:

- The application of a delay interest equal to the most recent refinancing rate of the European Central Bank plus a further ten points (law on modernisation and economy – LME – No. 2008-776 of 4 August 2008);
- The application of a flat-rate allowance for recovery costs of 40 euros (European Directive 2011/7 of 16 February 2011, law 2012-387 of 22 March 2012 and decree 2012-1115 of 2 October 2012),
- If recovery costs are higher than the amount of the flat-rate allowance, a supplementary compensation is applied, upon justification.

Any default of payment on the due date, as well as any refusal of acceptance of bill of exchange, upon its presentation, results, at the supplier's discretion, in the suspension or termination of all pending orders. The settlement of all partial deliveries is due to the date mentioned on the corresponding invoice and not at the date of delivery of the balance. Any deterioration in the purchaser's credit will justify the provision of a guarantee or a payment in cash, before the fulfilment of the received orders. Under no circumstances, the payments due to ASEM® may be suspended or have any reduction or set-off applied to them without written authorization by ASEM®.

No warranty holdback will be accepted by ASEM®, unless duly agreed previously. All references to this warranty holdback in the general conditions of sale are thereby not relevant.

ATTRIBUTION OF JURISDICTION

Except otherwise agreed, in the event of any dispute arising from any order, interpretation and execution of sale agreements, which fall under the Italian law, the court jurisdiction is the commercial court of Treviso.

DELIVERY AND INSTALLATION SHEET

To fill and return by telefax to : 0039 0422 827739 or e-mail: info@atcasem.it

COMPANY	
ADDRESS	
FLOOR No.	
CONTACT	
TELEPHONE	
ORDER REF.	
CABINET(S) REF.	

**more than 3 steps= 1 floor - ** if you order more cabinets, please notify if they are all for the same room or building*

1- DELIVERY DATE AND TIME

- The delivery will be possible from:
- Delivery time:

..... / /

Morning from to

Afternoon from to

2- ACCESS TO BUILDING

- Possibility of delivery with a 3.5 tons truck
- Flat surface
- Loading dock
- Forklift truck

yes no

yes no

yes no

yes no

3- INSTALLATION

- Would you like a preliminary visit?
- Floor (*indicate the no. of floors*)

yes no

ground f floor n°

- Goods elevator

yes no

If YES

- Maximum capacity of the goods elevator
- Sizes of the goods elevator (cm)

Kg

W..... x D..... x H.....

If NO

- Type of staircases (*spiral, winding, straight...*)
- Number of landing
- Manipulation depth minimum of 2,20 m
- Number of doors to cross
- Door sizes (cm)
- Path *number of meters from exiting the elevator/staircase to the installation site*
- Maximum floor load (Kg)
- Additional notes:

.....

.....

yes no

W..... x H.....

.....

Kg

Signatory NAME:
Job:

STAMP
and signature

Authorized dealer: